

HP Photosmart 8000 series User's Guide

English

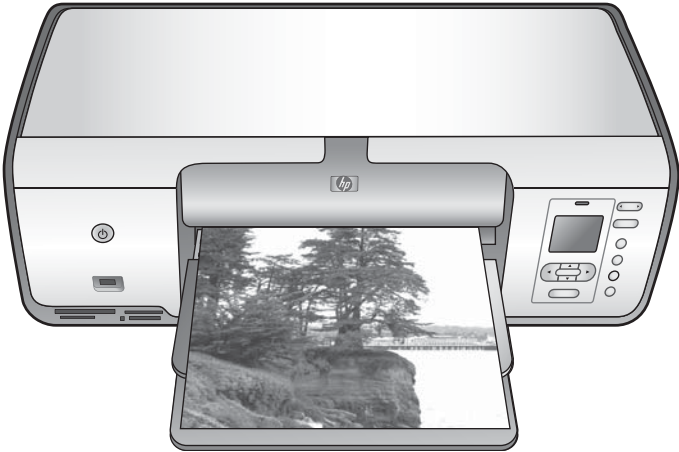



www.hp.com/support

Support for the following countries/regions is available at www.hp.com/support: Austria, Belgium, Central America & The Caribbean, Denmark, Spain, France, Germany, Ireland, Italy, Luxembourg, Netherlands, Norway, Portugal, Finland, Sweden, Switzerland, and the United Kingdom.

61 56 45 43	الجزائر
Argentina (Buenos Aires) Argentina	54-11-4708-1600 0-800-555-5000
Australia Australia (out-of-warranty)	1300 721 147 1902 910 910
800 171	البحرين
Brasil (Sao Paulo) Brasil	55-11-4004-7751 0-800-709-7751
Canada (Mississauga Area) Canada	(905) 206-4663 1-(800)-474-6836
Chile	800-360-999
中国	021-3881-4518 800-810-3888
Colombia (Bogota) Colombia	571-606-9191 01-8000-51-4746-8368
Costa Rica	0-800-011-1046
Česká republika	261 307 310
Ecuador (Andinatel)	1-999-119 ☎ 800-711-2884
Ecuador (Pacifitel)	1-800-225-528 ☎ 800-711-2884
2 532 5222	مصر
El Salvador	800-6160
Ελλάδα (από το εξωτερικό) Ελλάδα (εντός Ελλάδας) Ελλάδα (από Κύπρο)	+ 30 210 6073603 801 11 22 55 47 800 9 2649
Guatemala	1-800-711-2884
香港特別行政區	2802 4098
Magyarország	1 382 1111
India	1 600 44 7737
Indonesia	+62 (21) 350 3408
(0) 9 830 4848	ישראל
Jamaica	1-800-711-2884
日本	0570-000511
日本 (携帯電話の場合)	03-3335-9800

한국	1588-3003
Malaysia	1800 805 405
Mexico (Mexico City) Mexico	55-5258-9922 01-800-472-68368
22 404747	المغرب
New Zealand	0800 441 147
Nigeria	1 3204 999
Panama	1-800-711-2884
Paraguay	009 800 54 1 0006
Peru	0-800-10111
Philippines	2 867 3551
Polska	22 5666 000
Puerto Rico	1-877-232-0589
República Dominicana	1-800-711-2884
România	(21) 315 4442
Россия (Москва) Россия (Санкт-Петербург)	095 7973520 812 3467997
800 897 1444	السعودية
Singapore	6 272 5300
Slovakia	2 50222444
South Africa (International)	+ 27 11 2589301
South Africa (RSA)	086 0001030
Rest Of West Africa	+ 351 213 17 63 80
臺灣	02-8722-8000
ไทย	+66 (2) 353 9000
71 89 12 22	تونس
Trinidad & Tobago	1-800-711-2884
Türkiye	90 216 444 71 71
Україна	(380 44) 4903520
800 4520	الإمارات العربية المتحدة
United States	1-800-474-6836
Uruguay	0004-054-177
Venezuela (Caracas) Venezuela	58-212-278-8666 0-800-474-68368
Việt Nam	+84 88234530

Copyrights and trademarks

© Copyright 2005 Hewlett-Packard Development Company, L.P.

The information contained herein is subject to change without notice. Reproduction, adaptation or translation without prior written permission is prohibited, except as allowed under the copyright laws.

Notice

The only warranties for HP products and services are set forth in the express warranty statements accompanying such products and services. Nothing herein should be construed as constituting an additional warranty. HP shall not be liable for technical or editorial errors or omissions contained herein.

The Hewlett-Packard Development Company, L.P. shall not be liable for incidental or consequential damages in connection with, or arising out of the furnishing, performance, or use of this document and the program material which it describes.

Trademarks

HP, the HP logo, and Photosmart are property of Hewlett-Packard Development Company, L.P.

The SD logo is a trademark of its proprietor.

Microsoft, Windows, and Windows XP are registered trademarks of Microsoft Corporation.

Intel and Pentium are trademarks or registered trademarks of Intel

Corporation or its subsidiaries in the United States and other countries.

iPod is a trademark of Apple Computer, Inc.

Bluetooth is a trademark owned by its proprietor and used by Hewlett-Packard Company under license.

Other brands and their products are trademarks or registered trademarks of their respective holders.

The embedded software in the printer is based in part on the work of the Independent JPEG Group.

Portions of the software are © Copyright 1998, 1999, 2000 Thai Open Source Software Center Ltd. and Clark Cooper. © Copyright 2001, 2002, 2003 Expat maintainers.

The copyrights to certain photos within this document are retained by the original owners.

Regulatory model identification number for HP Photosmart 8001 - 8099 series

For regulatory identification purposes, the product is assigned a Regulatory Model Number. The Regulatory Model Number for the product is VCVRA-0506. This regulatory number should not be confused with the marketing name (HP Photosmart 8050, HP Photosmart 8053, etc.) or product number (Q6351A, Q6352A, etc.).

Environmental statements

Hewlett-Packard Company is committed to providing quality products in an environmentally sound manner.

Protecting the environment

This printer has been designed with several attributes to minimize impact on our environment. For more information, go to HP's Commitment to the Environment website at www.hp.com/hpinfo/globalcitizenship/environment/.

Ozone production

This product generates no appreciable ozone gas (O₃).

Paper use

This product is suited for the use of recycled paper according to DIN 19309.

Plastics

Plastic parts over 24 grams (0.88 ounces) are marked according to international standards that enhance the ability to identify plastics for recycling purposes at the end of the printer life.

Material Safety Data Sheets

Material Safety Data Sheets (MSDS) can be obtained from the HP website at www.hp.com/go/msds. Customers without Internet access should contact HP Customer Care.

Recycling program

HP offers an increasing number of product return and recycling programs in many countries, and partners with some of the largest electronics recycling centers throughout the world. HP conserves resources by reselling some of its most popular products.

Disposal of waste equipment by users in private households in the European Union:



This symbol on the product or on its packaging indicates that this product must not be disposed of with your other household waste. Instead, it is your responsibility to dispose of your waste equipment by handing it over to a designated collection point for the recycling of waste electrical and electronic equipment. The separate collection and recycling of your waste equipment at the time of disposal will help to conserve natural resources and ensure that it is recycled in a manner that protects human health and the environment. For more information about where you can drop off your waste equipment for recycling, please contact your local city office, your household waste disposal service or the shop where you purchased the product.

For more information regarding return and recycling of HP products generally, please visit: www.hp.com/hpinfo/globalcitizenship/environment/recycle/index.html.

Contents

1	Welcome	3
	Accessing the onscreen HP Photosmart Printer Help	3
	Printer parts	4
	Printer menu	6
2	Getting ready to print	9
	Loading paper	9
	Choosing the right paper	9
	Printing from the control panel or a computer	9
	Loading your paper	10
	Using print cartridges	11
	Purchasing replacement print cartridges	12
	Print cartridge tips	12
	Inserting and replacing the print cartridges	12
	When you are not using a print cartridge	13
3	Printing without a computer	15
	Getting connected	15
	Printing photos from a memory card	16
	Inserting a memory card	16
	Memory card types	16
	Supported file formats	17
	Deciding which photos to print	18
	Selecting a photo layout	19
	Selecting photos to print	20
	Printing your photos	21
	Removing a memory card	24
	Improving photo quality	24
	Getting creative	25
	Printing photos from a digital camera	27
	Printing photos from other Bluetooth devices	28
	Printing photos from an HP iPod	29
4	Printing from a computer	31
	Using creative options in the printer software	31
	HP Image Zone	31
	HP Image Zone Express	31
	HP Instant Share	32
5	Care and maintenance	33
	Cleaning and maintaining the printer	33
	Cleaning the outside of the printer	33
	Automatically cleaning the print cartridges	33
	Manually cleaning the print cartridge contacts	34
	Printing a test page	34
	Aligning the print cartridges	35
	Printing a sample page	35
	Updating the software	36
	Storing the printer and print cartridges	36

Storing the printer	36
Storing the print cartridges	37
Maintaining the quality of photo paper	37
Storing photo paper	37
Handling photo paper	37
6 Troubleshooting	39
Printer hardware problems	39
Printing problems	41
Error messages	46
Paper errors	46
Print cartridge errors	47
Memory card errors	48
Proof sheet errors	50
Bluetooth printing problems	51
7 HP Customer Care	53
HP Customer Care by phone	53
Placing a call	54
Return to HP repair service (North America only)	54
Additional warranty options	54
8 Specifications	55
System requirements	55
Printer specifications	56
9 HP Warranty	59
Index.....	61

1 Welcome

Thank you for purchasing an HP Photosmart 8000 series printer! With this new photo printer you can print beautiful photos, save photos to a computer, and create fun and easy projects with or without a computer.

This guide primarily explains how to print without a computer. To learn how to print from a computer, install the printer software and view the onscreen Help. For an overview of using a computer and the printer together, see [Printing from a computer](#). For information about installing the software, see the *Quick Start* booklet.

The printer comes with the following documentation:

- **Quick Start booklet:** The *HP Photosmart 8000 series Quick Start* booklet explains how to set up the printer, install the printer software, and print your first photo.
- **User's Guide:** The *HP Photosmart 8000 series User's Guide* is the book you are reading. This book describes the basic features of the printer, explains how to use the printer without connecting a computer, and contains hardware troubleshooting information.
- **HP Photosmart Printer Help:** The onscreen HP Photosmart Printer Help describes how to use the printer with a computer and contains software troubleshooting information.

Accessing the onscreen HP Photosmart Printer Help

After you have installed the HP Photosmart printer software on a computer, you can view the onscreen HP Photosmart Printer Help:

- **Windows PC:** From the **Start** menu, select **Programs** (in Windows XP, select **All Programs**) > **HP** > **Photosmart 8000 series** > **Photosmart Help**.
- **Macintosh:** Select **Help** > **Mac Help** in the Finder, then select **Help Center** > **HP Image Zone Help** > **HP Photosmart Printer Help**.

Printer parts

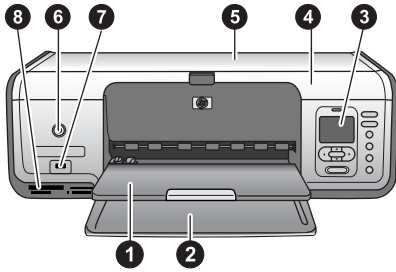

Front of printer

- | | |
|---|--|
| 1 | Output tray: After printing, remove your photos and documents from this tray. |
| 2 | Main tray: Place plain paper, transparencies, envelopes, or other media in this tray for printing. |
| 3 | Printer screen: Use this screen to view your photos and menu options. |
| 4 | Main cover: Raise the main cover to access the print cartridges. |
| 5 | Top cover: Open the top cover to access the Photo cassette. Use the Photo cassette to print on smaller photo paper. |
| 6 | On: Press this button to turn on the printer or put it into power save mode. |
| 7 | Camera port: Connect a PictBridge-compatible digital camera, the optional HP Bluetooth® wireless printer adapter, or an HP iPod to this port. |
| 8 | Memory card slots: Insert memory cards here. |

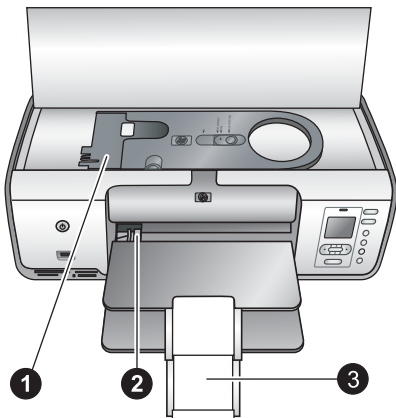

Inside view

- | | |
|---|---|
| 1 | Photo cassette: Load photo paper or other supported small media into this cassette, and insert the cassette into the Main tray for printing. For information on how to load the photo cassette, see Loading your paper . |
| 2 | Paper-width guide: Adjust this guide for different paper widths. |
| 3 | Output tray extender: Lift the tab, and then pull it towards you to extend the Output tray. The Output tray extender catches the printed paper as it ejects from the printer. |

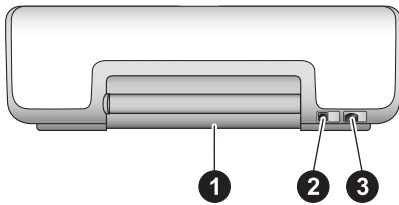

Back of printer

- | | |
|---|--|
| 1 | Rear access door: Open this door to clear a paper jam. |
| 2 | USB port: Use this port to connect a computer to the printer. |
| 3 | Power cord connection: Use this port to connect the power cord included with the printer. |

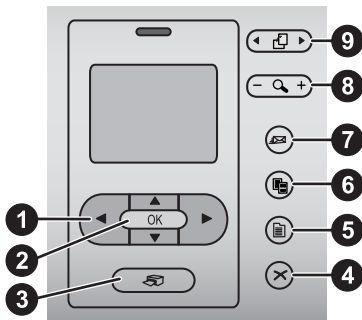

Control panel

- | | |
|---|--|
| 1 | Select Photos arrows: Scroll through the photos and control video playback on a memory card. |
| 2 | OK: Select a menu or dialog choice and play/pause a video clip during playback. |
| 3 | Print: Print selected photos from the inserted memory card. |
| 4 | Cancel: Deselect photos, to exit a menu, or to stop an action you have requested. |
| 5 | Menu: View the printer menu. |
| 6 | Layout: Choose a photo layout. |
| 7 | HP Instant Share: Send a photo via e-mail (if connected). For more information, see Getting connected . |
| 8 | Zoom: Enter Zoom mode and zoom in on the currently displayed photo, and to exit 9-up view mode. |
| 9 | Rotate: Rotate the currently displayed photo. |

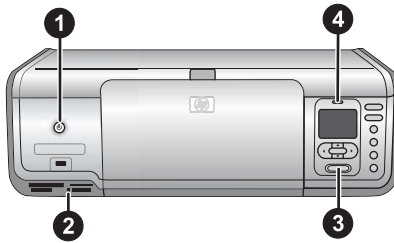

Indicator lights

1	On light: Solid green if the printer is on, otherwise off.
2	Memory Card light: Solid green if a memory card is correctly inserted; flashing green if the printer is accessing a memory card; and off if no memory card is inserted or more than one card is inserted.
3	Print light: Solid green if the printer is ready to print, pulsing green if the printer is busy printing.
4	Status light: Flashing red if there is an error or if some user action is required.

Printer menu

Press **Menu** to access the printer menu. If you are viewing a submenu, pressing **Menu** returns you to the main printer menu.

To navigate the printer menu

- Press **▲** or **▼** to scroll through the menu options displayed on the printer screen. Menu items that are not accessible are grayed out.
- Press **OK** to open a menu or select an option.
- Press **Cancel** to exit the current menu.

Print Options

- **Print all:** Print all the photos on the memory card inserted in the printer.
- **Print proof sheet:** Print a proof sheet of all photos on the inserted memory card. The proof sheet allows you to select photos to print, number of copies, and the print layout.
- **Scan proof sheet:** Scan a printed proof sheet marked with selected photos for printing.
- **Video action prints:** Print nine frames that are automatically selected from your video clip.
- **Print range:** Select the beginning and the end of the print range using the **Select Photos** arrows.
- **Print index page:** Print thumbnail views of all photos on the inserted memory card.
- **Print panoramic photos:** Select to turn panoramic printing **On** or **Off** (default). Select **On** to print all selected photos with a 3:1 aspect ratio; load 10 x 30 cm (4 x 12 inch) paper before printing.
- **Print stickers:** Select to turn sticker printing **On** or **Off** (default). Select **On** to print 16 photos per page; load special sticker media if desired.
- **Passport photo mode:** If you select **On**, the printer prompts you to select the passport photo size. Passport mode tells the printer to print all photos in the

selected size. Each page contains one photo. However, if you specify several copies of the same photo, they all appear on the same page (if enough space is available). Allow photos to dry for one week before laminating.

Edit

- **Remove red-eye:** Select to remove red-eye from the photo displayed on the printer screen. The printer automatically removes red-eye by default. Use the **Preferences** menu to disable automatic red-eye removal.
- **Photo brightness:** Press ► or ◀ to increase or decrease the photo brightness.
- **Add frame:** Use the **Select Photos arrows** to select a pattern and a color for a frame.
- **Add color effect:** Use the **Select Photos arrows** to select a color effect. The color effect does not affect frames created with the **Add frame** option. These color effects are only for printing and do not change your original digital photo.

Tools

- **View 9-up:** View nine images at once from the inserted memory card.
- **Slide show:** Press **OK** to pause and unpause the slide show; press **Cancel** to stop the slide show.
- **Print quality:** Choose either **Best** (default) or **Normal** print quality.
- **Print sample page:** Select to print a sample page useful for checking the print quality of the printer.
- **Print test page:** Select to print a test page containing information about the printer that can help in troubleshooting problems.
- **Clean cartridges:** Select to clean the print cartridges. After the cleaning finishes, the printer prints a test page. You have the option to clean the cartridges again if the test page shows that they are still not clean.
- **Align cartridges:** Select to align the print cartridges.

Bluetooth

- **Device address:** Some devices with Bluetooth wireless technology require you to enter the address of the device they are trying to locate. This menu option shows the device address.
- **Device name:** You can select a device name for the printer that appears on other devices with Bluetooth wireless technology when they locate the printer.
- **Passkey:** Press ▲ to increase number by one; press ▼ to decrease the number. Press **OK** to move to next number.
If the printer Bluetooth **Security level** is set to **High**, you can assign a numerical passkey that Bluetooth device users trying to locate the printer must enter before printing. The default passkey is 0000.
- **Visibility:** You can set the Bluetooth-equipped printer to be visible or invisible to other devices with Bluetooth wireless technology by changing this accessibility option. When **Visibility** is set to **Not visible**, only devices that know the device address can print to it.
- **Security level:** Select **Low** or **High**. The **Low** setting does not require users of other devices with Bluetooth wireless technology to enter the printer passkey.

High requires users of other devices with Bluetooth wireless technology to enter the printer passkey.

- **Reset Bluetooth options:** Select to reset all items in the Bluetooth menu to their default values.

Help

- **Memory cards:** Press ▲ or ▼ to scroll through the memory cards supported by the printer, then press **OK** to see how to insert the memory card.
- **Cartridges:** Press ▲ or ▼ to scroll through the HP print cartridges available for the printer, then press **OK** to see how to insert the cartridge.
- **Photo Sizes:** Press ▲ or ▼ to scroll through the available photo sizes.
- **Paper Loading:** Press ▲ or ▼ to scroll through information on loading paper.
- **Paper Jams:** Select to see how to remove a paper jam.
- **Camera Connect:** Select to see where to connect a PictBridge-compatible digital camera to the printer.

Preferences

- **SmartFocus:** Select **On** (default) or **Off**. This setting improves blurred photos.
- **Adaptive lighting:** Select **On** (default) or **Off**. This setting improves lighting and contrast.
- **Date/time:** Use this option to include the date and/or time on your printed photos.
- **Colorspace:** The Auto-select default tells the printer to use the Adobe RGB colorspace, if available. The printer defaults to sRGB if Adobe RGB is not available.
- **Paper detect:** Select **On** (default) and the printer will automatically detect the paper type and size when you print. When you select **Off**, you will be asked to select the paper type and size each time you print.
- **Preview animation:** Select **On** (default) or **Off**. When this feature is turned on, after you select a photo the printer will briefly display a print preview of the photo in the selected layout. Note: This feature is not available in all printer models.
- **Video enhancement:** Select **On** or **Off** (default). When you select **On**, the quality of photos printed from video clips will be improved.
- **Auto red-eye removal:** Select **On** (default) or **Off** to automatically remove red-eye effect from images.
- **Restore defaults:** Restores factory settings for all menu items except **Select language** and **Select country/region** (under **Language** in **Preference** menu) and Bluetooth settings (under **Bluetooth** in the main printer menu). This setting does not affect HP Instant Share or Network defaults.
- **Language:** Select to indicate the language you want used on the printer screen, and the country/region setting. The country/region setting determines the supported media sizes.

2 Getting ready to print

This section includes information on the following topics:

- Loading paper
- Using print cartridges

Loading paper

Learn how to choose the right paper for your print job and how to load it in the Main tray or Photo cassette for printing.

Choosing the right paper

For a list of available HP paper, or to purchase supplies, go to:

- www.hpshopping.com (U.S.)
- www.hp.com/go/supplies (Europe)
- www.jpn.hp.com/supply/inkjet (Japan)
- www.hp.com/paper (Asia/Pacific)

To get the best results from the printer, choose from these high-quality HP photo papers.

To print	Use this paper
High-quality, long-lasting prints and enlargements	HP Premium Plus photo paper (Also known as Colorfast Photo Paper in some countries/regions.)
Medium- to high-resolution images from scanners and digital cameras	HP Premium photo paper
Instant dry, water and fingerprint-resistant glossy photos	HP Advanced photo paper
Casual and business photos	HP Photo paper HP Everyday photo paper
Text documents, draft versions, test and alignment pages	HP Multipurpose paper

To keep your paper in good condition for printing:

- Store the photo paper in its original packaging or in a resealable plastic bag.
- Keep the paper flat in a cool, dry place. If the corners curl, place the paper in a plastic bag and gently bend it in the opposite direction until it lies flat.
- Hold photo paper by the edges to avoid smears.

Printing from the control panel or a computer

When printing from a computer, the printer prints paper sizes from 7.6 x 12.7 cm to 22 x 61 cm (3 x 5 inch to 8.5 x 14 inch). The list below describes which paper sizes

are supported when printing directly from the control panel. Supported sizes when printing from the control panel A6, A4, 10 x 15 cm (4 x 6 inch) with or without a tab, 3.5 x 5 inch, 5 x 7 inch, 8.5 x 11 inch, Hagaki, and L-size.

Loading your paper

Paper loading tips:

- Before loading paper, slide out the paper-width guide to make room for the paper.
- Load only one type and size of paper at a time. Do not mix paper types or sizes in the Main tray or the Photo cassette.
- After loading paper, extend the Output tray extender to hold your printed pages. This prevents printed pages from dropping off of the Output tray.

Use the directions in the following table to load the most commonly used paper sizes into the printer.

Paper type	How to load	Tray to load				
<ul style="list-style-type: none"> • 10 x 15 cm (4 x 6 inch) photo paper (with or without tab) • 7.62 x 13 cm (3 x 5 inch) photo paper • Index cards • Hagaki cards • A6 paper • L-size cards 	<ol style="list-style-type: none"> 1. Remove any paper that is loaded in the Main tray. 2. Raise the top cover and remove the Photo cassette. 3. Squeeze the paper-width guide and slide it to the left until it stops. 4. Load up to 20 sheets of paper into the Photo cassette with the side to be printed facing down. If you are using tabbed paper, insert the tabbed end first. 5. Adjust the paper-length and paper-width guides of the Photo cassette to fit the loaded paper. 6. Line up the Photo cassette with the right side of the Main tray, then slide it into the printer until it snaps into place. 7. Extend the Output tray extender to hold your printed pages. 8. When you finish printing, remove the Photo cassette and store it in the cassette storage area. 	<p>Photo cassette into the Main tray</p> <table border="1"> <tr> <td>1</td> <td>Paper-width guide</td> </tr> <tr> <td>2</td> <td>Paper-length guide</td> </tr> </table>	1	Paper-width guide	2	Paper-length guide
1	Paper-width guide					
2	Paper-length guide					
<ul style="list-style-type: none"> • Letter or A4 paper • Transparencies 	<ol style="list-style-type: none"> 1. Remove any paper that is loaded in the Main tray. 	<p>Main tray – larger paper sizes</p>				

(continued)

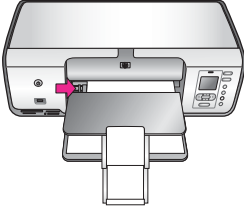
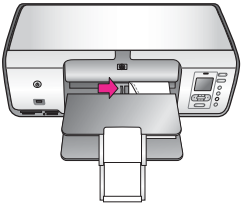
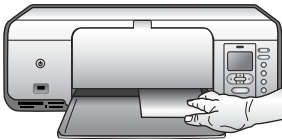
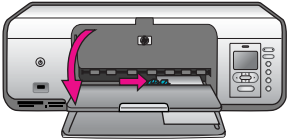
Paper type	How to load	Tray to load
<ul style="list-style-type: none">• 20 x 25 cm (8 x 10 inch) photo paper• Envelopes 28.0 cm (11 inches) wide and greater	<ol style="list-style-type: none">2. Squeeze the paper-width guide and slide it to the left until it stops.3. Load plain paper, photo paper, envelopes or transparencies in the Main tray with the side to be printed facing down. Load envelopes with the flap on the left. Tuck the flaps inside the envelopes to avoid paper jams.4. Squeeze the paper-width guide and slide it to the right so it touches the edges of the paper without bending it.5. Extend the Output tray extender to hold your printed pages.	  <p>Main tray – envelopes</p>
<ul style="list-style-type: none">• 13 x 18 cm (5 x 7 inch) photo paper• 2L-size paper• 10 x 20 cm (4 x 8 inch) photo cards• B5 paper• Envelopes smaller than 28.0 cm (11 inches) wide	<ol style="list-style-type: none">1. Raise the Output tray.2. Remove any paper that is loaded in the Main tray.3. Squeeze the paper-width guide and slide it to the left until it stops.4. Load photo paper with the side to be printed facing down. If you are using tabbed paper, insert the tabbed end first. Load envelopes with the flap on the left. Tuck the flaps inside the envelopes to avoid paper jams.5. Squeeze the paper-width guide and slide it to the right so it touches the edges of the paper without bending it.	<p>Main tray – smaller paper sizes</p>  <p>Tip Raise the Output tray before loading small paper sizes not supported by the Photo cassette. Lower the Output tray after loading the paper.</p> 

Using print cartridges

Your HP Photosmart 8000 series printer can print color and black-and-white photos. HP provides different types of print cartridges so you can choose the best cartridges for your project.

Purchasing replacement print cartridges

When purchasing replacement cartridges, refer to the cartridge numbers that appear on the back cover of this guide. These cartridge numbers may vary by country/region. You can also find the cartridge numbers in the printer software.

To find the correct print cartridge numbers for Windows users

1. Right-click the HP Digital Imaging Monitor icon on the far right of the Windows® taskbar and select **Launch/Show HP Solution Center**.
2. Select **Settings**, and then select **Print Settings > Printer Toolbox**.
3. Select the **Estimated Ink Levels** tab, and then click **Print Cartridge Information**.

To find the correct print cartridge numbers for Macintosh users

1. Click **HP Image Zone** in the Dock.
2. Choose **Maintain Printer** from the **Settings** pop-up menu.
3. Click **Launch Utility**, and then choose **Supplies Status** from the pop-up menu.

Print cartridge tips

HP Vivera Inks deliver true-to-life photo quality and exceptional fade resistance resulting in vivid colors that last for generations! HP Vivera Inks are specially-formulated and scientifically tested for quality, purity, and fade resistance.

For best print quality, HP recommends that you install all retail print cartridges before the install-by date stamped on the box.

For optimal printing results, HP recommends using only genuine HP print cartridges. Genuine HP print cartridges are designed and tested with HP printers to help you easily produce great results, time after time.



Note HP cannot guarantee the quality or reliability of non-HP ink. Printer service or repairs required as a result of printer failure or damage attributable to the use of non-HP ink will not be covered under warranty.



Caution To prevent ink loss or spillage: leave the print cartridges installed while transporting the printer, and avoid leaving used print cartridge(s) out of the printer for extended lengths of time.

Inserting and replacing the print cartridges

To prepare the printer and cartridges

1. Make sure the power is on and you have removed the cardboard from inside the printer.
2. Raise the main cover of the printer.
3. Remove the bright pink tape from the cartridges.

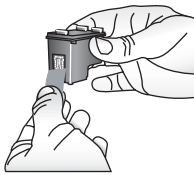

Note Do not touch the ink nozzles or the copper-colored contacts, and do not re-tape the cartridges.



To insert the cartridges

1. If you are replacing an HP Black, HP Photo, or HP Gray Photo cartridge, push down and pull outward on the cartridge in the **right** stall to remove it.
2. Hold the new cartridge with the label on top. Slide the cartridge at a slight upward angle into the **right** stall so the copper-colored contacts go in first. Gently push the cartridge until it snaps into place.



Caution To avoid print carriage jams, make sure the print cartridge snaps securely into place as you insert it.

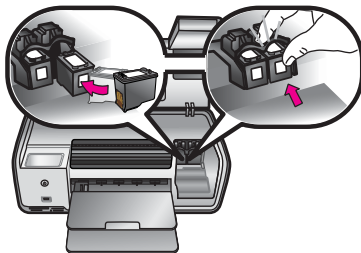

3. Repeat the previous steps to install the HP Tri-color cartridge in the **left** stall.
4. Lower the main cover.

When you are not using a print cartridge

Whenever you remove a print cartridge from the printer, store it in the print cartridge protector. The cartridge protector keeps the ink from drying out when the cartridge is not being used. Failure to properly store your cartridge can cause the cartridge to malfunction.

- To insert a cartridge into the cartridge protector, slide the cartridge into the protector at a slight angle and snap it securely into place.

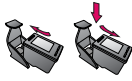

Once you have inserted a cartridge into the cartridge protector, place it in the storage area located in the printer.

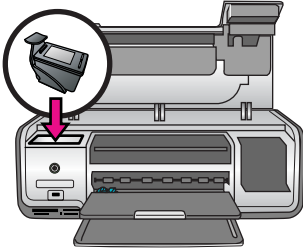

3 Printing without a computer

The HP Photosmart 8000 series printer lets you select, enhance, and print photos without even turning on the computer. Once you've set up the printer using the instructions in the *Quick Start* booklet, you can insert a memory card in the printer and print your photos using the buttons on the printer control panel.

Once you have set up the printer, you can print from any of the following:

- Memory card
- PictBridge-compatible digital camera
- Bluetooth device
- HP iPod (with photos stored in it)

Getting connected

This printer offers several ways of connecting to computers or other devices. Each connection type lets you do different things.

Connection type and what you need	This lets you...
Memory cards A compatible digital camera memory card Insert the memory card into the appropriate memory card slot on the front of the printer.	Print directly from a memory card to the printer. See Printing photos from a memory card . Print quick proofs of photos on a memory card directly from the printer control panel.
PictBridge A PictBridge-compatible digital camera and a USB cable. Connect the camera to the camera port on the front of the printer.	Print directly from a PictBridge-compatible digital camera to the printer. For more information, see Printing photos from a digital camera and the camera documentation.
Bluetooth An optional HP Bluetooth wireless printer adapter. Connect the HP Bluetooth wireless printer adapter to the camera port on the front of the printer.	Print from any device with Bluetooth wireless technology to the printer.
HP iPod An HP iPod and the USB cable that came with it. Connect the HP iPod to the camera port on the front of the printer.	Print directly from an HP iPod (with photos stored in it) to the printer. For more information, see Printing photos from an HP iPod .

Printing photos from a memory card

You can print photos from a memory card by inserting the card into the printer and using the printer control panel to select, enhance, and print photos. You can also print camera-selected photos—photos you marked for printing using a digital camera—directly from a memory card.

Printing from a memory card is quick and easy, and does not drain the digital camera batteries. For more information on inserting memory cards, see [Inserting a memory card](#).

This section tells you how to do the following:

- Insert a memory card
- Decide which photos to print
- Select a photo layout
- Select photos
- Improve photo quality
- Print the selected photos

Inserting a memory card

After you have taken pictures with a digital camera, you can remove the memory card from the camera and insert it into the printer to view and print your photos. The printer can read the following types of memory cards: CompactFlash, Memory Stick, Microdrive, MultiMediaCard, Secure Digital, and xD-Picture Card.

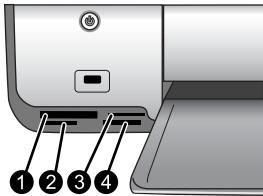

Memory card slots

1	CompactFlash I and II, Microdrive
2	Secure Digital, MultiMediaCard (MMC)
3	xD-Picture Card
4	Memory Stick



Caution Using any other type of memory card may damage the memory card and the printer.

Memory card types

Find your memory card in the following table and use the instructions to insert the card into the printer.







Guidelines:

- Insert only one memory card at a time.
- Gently push the memory card into the printer until it stops. The memory card does not insert all the way into the printer; do not try to force it.
- When the memory card is inserted correctly, the Memory Card light flashes and then remains solid green.



Caution 1 Inserting the memory card any other way may damage the card and the printer.

Caution 2 Do not pull out a memory card while the Memory Card light is flashing green. For more information, see [Removing a memory card](#).

Memory card	How to insert the memory card
CompactFlash 	<ul style="list-style-type: none">● Front label faces up, and if the label has an arrow, the arrow points toward the printer● Edge with metal pinholes goes into the printer first
Memory Stick 	<ul style="list-style-type: none">● Angled corner is on the left● Metal contacts face down● If you are using a Memory Stick Duo or Memory Stick PRO Duo card, attach the adapter that came with the card before you insert the card into the printer
Microdrive 	<ul style="list-style-type: none">● Front label faces up, and if the label has an arrow, the arrow points toward the printer● Edge with metal pinholes goes into the printer first
MultiMediaCard 	<ul style="list-style-type: none">● Angled corner is on the right● Metal contacts face down
Secure Digital 	<ul style="list-style-type: none">● Angled corner is on the right● Metal contacts face down
xD-Picture Card 	<ul style="list-style-type: none">● Curved side of card points toward you● Metal contacts face down

Supported file formats

The printer can recognize and print JPEG and uncompressed TIFF files directly from the memory card. You can also print video clips from MPEG-1, Motion-JPEG QuickTime, and Motion-JPEG AVI files. If your digital camera saves photos and video clips in other file formats, save the files to your computer and print them using a software application. For more information, see the onscreen HP Photosmart Printer Help.

Deciding which photos to print

You can decide which photos to print by viewing the photos on the printer screen, by printing a photo index, or by printing a proof sheet.

To decide which photos to print, try one of these options

View photos on the printer screen

You can view photos one at a time or nine at a time on the printer screen.

Tip To move quickly through the photos, press and hold **Select Photos** ◀ or ▶. When you reach the last photo in either direction, the display continues with the first or last photo.

To view photos

1. Insert a memory card.
2. Press **Select Photos** ◀ or ▶. Press and hold the button to view the photos rapidly. When you reach the last photo in either direction, the display returns to the first or last photo and continues.

To view nine photos at a time

1. Insert a memory card.
2. Press **Menu**.
3. Select **Tools**, then press **OK**.
4. Select **View 9-up**, then press **OK**.
5. Use the **Select Photos** arrows to move through the photos.

To exit 9-up view mode and return to viewing one photo at a time, press **Zoom**.

Print a photo index

A photo index shows thumbnail views and index numbers for up to 2000 photos on a memory card. Use plain paper instead of photo paper to cut costs.

A photo index may be several pages long.

To print a photo index

1. Insert a memory card.
2. Load several sheets of plain paper in the Main tray.
3. Press **Menu**.
4. Select **Print options**, then press **OK**.
5. Select **Print index page**, then press **OK**.

Print a proof sheet

A proof sheet shows thumbnail views of all photos stored on a memory card. A proof sheet is different than a photo index because it

To print a proof sheet

1. Insert a memory card.
 2. Load several sheets of plain paper in the Main tray.
 3. Press **Menu**.
 4. Select **Print options**, then press **OK**.
-

(continued)

To decide which photos to print, try one of these options



provides spaces for you to select photos to print, specify the number of copies to print, and select the photo layout.

5. Select **Print proof sheet**, then press **OK**.

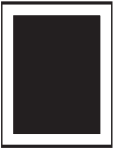

Note A proof sheet may be several pages long.

Selecting a photo layout

Press **Layout** on the printer to select a layout for the photos you want to print. All photos selected from the printer control panel will print in this layout. The actual size of the prints will vary according to the size of paper you load in the printer, as shown in the following table. The printer may rotate the photos to fit the layout.

Layout	Paper size (photo size)
1 per page borderless 	4 x 6 inch (4 x 6 inch) 10 x 15 cm (10 x 15 cm) A6 (10.5 x 14.8 cm) 5 x 7 inch (5 x 7 inch) A5 (14.8 x 21.0 cm) A4 (21.0 x 29.7 cm) 8.5 x 11 inch (8.5 x 11 inch)
1 per page 	3.5 x 5 inch (3.25 x 4.75 inch) 4 x 6 inch (3.75 x 5.75 inch) 10 x 15 cm (9.53 x 14.6 cm) 5 x 7 inch (4.75 x 6.75 inch) 8 x 10 inch (7.75 x 9.75 inch) 8.5 x 11 inch (8 x 10 inch) A6 (9.86 x 14.16 cm) A4 (20 x 25 cm) Hagaki (9.36 x 14.16 cm) L (8.25 x 12.06 cm)
2 per page 	3.5 x 5 inch (2.25 x 3.25 inch) 4 x 6 inch (2.75 x 3.75 inch) 5 x 7 inch (3.25 x 4.75 inch) 8 x 10 inch (4.75 x 6.5 inch) 8.5 x 11 inch (5 x 7 inch) A6 (6.92 x 9.86 cm) A4 (13 x 18 cm) Hagaki (6.8 x 9.36 cm) L (5.87 x 8.25 cm)

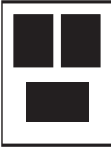
(continued)

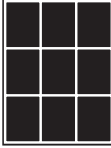
Layout	Paper size (photo size)
<p>3 per page</p> 	<p>3.5 x 5 inch (1.5 x 2.25 inch) 4 x 6 inch (1.75 x 2.625 inch) 5 x 7 inch (2.25 x 3.375 inch) 8 x 10 inch (3.33 x 5 inch) 8.5 x 11 inch (4 x 6 inch) A6 (4.77 x 7.15 cm) A4 (10 x 15 cm) Hagaki (4.52 x 6.78 cm) L (3.96 x 5.94 cm)</p>
<p>4 per page</p> 	<p>3.5 x 5 inch (1.5 x 2.25 inch) 4 x 6 inch (1.75 x 2.5 inch) 5 x 7 inch (2.2 x 3.25 inch) 8 x 10 inch (3.5 x 4.75 inch) 8.5 x 11 inch (3.5 x 5 inch) A6 (4.77 x 6.92 cm) A4 (9 x 13 cm) Hagaki (4.52 x 6.5 cm) L (3.96 x 5.7 cm)</p>
<p>9 per page</p> 	<p>3.5 x 5 inch (1 x 1.375 inch) 4 x 6 inch (1.125 x 1.5 inch) 5 x 7 inch (1.5 x 2 inch) 8 x 10 inch (2.25 x 3 inch) 8.5 x 11 inch (2.5 x 3.25 inch) – Wallet size A6 (3.07 x 4.05 cm) A4 (6.4 x 8.4 cm) Hagaki (2.9 x 3.86 cm) L (2.53 x 3.36 cm)</p>

Selecting photos to print

If you want to...	Follow these steps
<p>Select a photo</p> <p>Note You can also select photos from an HP iPod. For more information, see Printing photos from an HP iPod.</p>	<ol style="list-style-type: none"> 1. Insert a memory card. 2. Press Select Photos ◀ or ▶ to display the photo you want to select. 3. Press OK to select the displayed photo. A check mark appears in the bottom corner of the photo.

(continued)

If you want to...	Follow these steps
<p>Select more than one copy of a photo</p>	<ol style="list-style-type: none">1. Insert a memory card.2. Press Select Photos ◀ or ▶ to display the photo you want to select.3. Press OK once for each copy of the displayed photo you want to print. The number of times that the photo has been selected appears at the bottom of the photo. For example, if you select a photo twice, x2 appears.
<p>Deselect one or all photos</p> <p>When you deselect a photo, the printer discards any changes you made to the print settings for that photo.</p> <p>Note Deselecting photos does not delete them from the memory card.</p>	<ol style="list-style-type: none">1. Press Select Photos ◀ or ▶ to display the photo you want to deselect.2. Press Cancel to deselect the displayed photo for printing. If a photo was selected multiple times, the printer removes one selection of the photo each time you press Cancel. <p>To deselect all photos, press Cancel until a message appears on the printer screen asking if you want to deselect all photos. Select Yes, then press OK.</p>
<p>Select photos on a proof sheet</p> <p>After you print a proof sheet, you can use it to select specific photos to print.</p> <p>For information about printing a proof sheet, see Deciding which photos to print.</p>	<ol style="list-style-type: none">1. Select the photos you want to print by filling in the circle below each photo with a dark pen.2. Select the number of copies you want of each photo by filling in the copies section. Make sure to only fill in one choice.3. Select a photo layout in the print layout section. Make sure to only fill in one choice. <p>Once you fill out the proof sheet, scan it to print the selected photos.</p>

Printing your photos

If you want to...	Follow these steps:
<p>Print one photo</p> <p>Before you begin, make sure that the memory card is inserted in the printer and the Main tray or Photo cassette is loaded with the correct paper.</p>	<ol style="list-style-type: none">1. Press Layout until the desired layout appears.2. Press Select Photos ◀ or ▶ to display the photo you want to print.3. Press OK to select the photo.4. Press Print to print the photo.
<p>Print multiple photos</p> <p>Before you begin, make sure that the memory card is inserted in the printer and the</p>	<ol style="list-style-type: none">1. Press Layout until the desired layout appears.2. Press Select Photos ◀ or ▶ to display the photos you want to print.3. When a photo you want to print appears on the printer screen, press OK to select the photo.

(continued)

If you want to...	Follow these steps:
<p>Main tray or Photo cassette is loaded with the correct paper.</p>	<ol style="list-style-type: none"> 4. To select additional photos, use the Select Photos ◀ and press OK when a photo you want to print appears on the screen. 5. When you have selected all the photos you want to print and have made any desired changes to the print settings, press Print.
<p>Print more than one copy of a photo</p> <p>Before you begin, make sure that the memory card is inserted in the printer and the Main tray or Photo cassette is loaded with the correct paper.</p>	<ol style="list-style-type: none"> 1. Press Layout until the desired layout appears. 2. Press Select Photos ◀ or ▶ to display the photo you want to print. 3. Press OK once for each copy of the displayed photo you want to print. 4. Press Print.
<p>Print all photos on the memory card</p> <p>Before you begin, make sure that the memory card is inserted in the printer and the Main tray or Photo cassette is loaded with the correct paper. Use the Photo cassette for smaller photo paper sizes.</p>	<ol style="list-style-type: none"> 1. Press Layout until the desired layout appears. 2. Press Menu. 3. Select Print options, then press OK. 4. Select Print all, then press OK to begin printing all photos on the memory card. The first frame of each video clip on the memory card will also print.
<p>Print a continuous range of photos</p> <p>Before you begin, make sure that the memory card is inserted in the printer and the Main tray or Photo cassette is loaded with the correct paper.</p>	<ol style="list-style-type: none"> 1. Press Layout until the desired layout appears. 2. Press Menu. 3. Select Print options, then press OK. 4. Select Print range, then press OK. 5. Press Select Photos ◀ or ▶ until the first photo you want to print appears on the left side of the printer screen, then press OK. 6. Press Select Photos ◀ or ▶ until the last photo you want to print appears on the right side of the printer screen, then press OK. The selected range of photos begins printing. The first frame of each video clip in the selected range will also print.
<p>Print the photos you selected on a proof sheet</p> <p>After you've filled out the proof sheet as described in Selecting photos to print, you can scan it to print the selected photos. Make sure the same memory card used when you printed the proof</p>	<ol style="list-style-type: none"> 1. Make sure that the memory card is inserted in the printer, and then press Menu. 2. Select Print options, and then press OK. 3. Select Scan proof sheet, and then press OK. 4. Load the proof sheet in the Main tray with the printed side facing down and the top of the page facing toward the printer. If the printed proof sheet spans several pages, insert the pages in reverse order to allow the printer to scan them all properly.

(continued)

If you want to...	Follow these steps:
<p>sheet is inserted when you scan that proof sheet.</p> <p>Photos printed from a proof sheet use the default print settings. Any print settings you have applied to photos, such as cropping, color effects, and decorative frames, are ignored.</p>	<ol style="list-style-type: none">5. Press OK to begin scanning.6. When a message appears on the printer screen prompting you to load paper, then load the photo paper.7. Press OK to start printing the photos you selected on the proof sheet.
<p>Print photos from video clips</p> <p>You can view video clips on the printer screen, and select and print individual frames.</p> <p>When you first insert a memory card containing a video clip, the printer uses the first frame of the video clip to represent the clip on the printer screen.</p> <p>The printer recognizes video clips recorded in these formats:</p> <ul style="list-style-type: none">• Motion-JPEG AVI• Motion-JPEG QuickTime• MPEG-1 <p>The printer ignores video clips in any other format.</p>	<p>Before you begin, make sure that the memory card is inserted in the printer and the Main tray is loaded with the correct paper.</p> <ol style="list-style-type: none">1. Press Layout until the desired layout appears in the bottom of the printer screen.2. Press Select Photos ◀ or ▶ to display the video clip you want to print.3. Press OK to play the video clip. You can fast-forward the video while it is playing by pressing and holding Select Photos ▶.4. To pause the video while it is playing, press OK. You can play the video in slow motion by pressing and holding Select Photos ▶ while the video is paused.5. To select the displayed video frame, press OK.6. Press Print to begin printing.
<p>Print a video action print</p> <p>A video action print is a series of nine automatically selected frames from a video clip.</p>	<ol style="list-style-type: none">1. Insert a memory card containing one or more video clips.2. Load photo paper, and then press Menu.3. Select Print options, and then press OK.4. Select Video action prints, and then press OK.5. Press Select Photos ◀ or ▶ to highlight the video clip you want to print as a video action print.6. Press OK, then press Print.
<p>Print camera-selected photos from a memory card</p> <p>When you select photos for printing using a digital camera, the camera creates a Digital Print Order Format (DPOF) file that identifies the selected photos. The printer can read DPOF 1.0 and 1.1 files directly from a memory card.</p>	<ol style="list-style-type: none">1. Use the digital camera to select the photos you want to print. For more information, see the documentation that came with the camera.2. If you selected default as the photo layout with the camera, press Layout to select a photo layout. If you select a photo layout other than default with the camera, photos print in the camera-selected layout regardless of the printer setting.

(continued)

If you want to...	Follow these steps:
After printing, the printer deletes the DPOF file and unmarks the photos.	<ol style="list-style-type: none"> 3. Remove the memory card from the digital camera and insert it into the printer. 4. When Print DPOF photos? appears on the printer screen, select Yes, and then press OK. The photos you selected with a camera will print.
Stop printing	To stop a print job in progress, press Cancel .

Removing a memory card

Wait until the Memory Card light stops flashing and remains solid green, then gently pull the memory card to remove it from the printer.



Caution If the Memory Card light is flashing green, then the printer is accessing the memory card. Do not remove a memory card while it is being accessed because this may damage the printer or the memory card.

Improving photo quality

The printer provides a variety of enhancements that can improve the quality of a photo printed from a memory card. These print settings do not change the original photo. They only affect printing.

Problem	How to correct it
<p>Red-eye in flash photos</p> <p>By default, the automatic red-eye removal feature is turned on in the Preferences menu. This feature removes red-eye from all photos just before printing. If you still have red-eye problems, remove red-eye from individual photos using the Remove red-eye feature in the Edit menu.</p>	<p>Automatic red-eye removal (all photos)</p> <ol style="list-style-type: none"> 1. Press Menu. 2. Select Preferences, then press OK. 3. Select Auto remove red-eye, then press OK. 4. Select On, then press OK. <p>Manual red-eye removal (one photo at a time)</p> <ol style="list-style-type: none"> 1. Press Select Photos ◀ or ▶ to display the photo you want to fix. 2. Press Menu. 3. Select Edit, then press OK. 4. Select Remove red-eye, then press OK.
<p>Photos with poor brightness</p>	<p>To adjust the brightness of a photo</p> <ol style="list-style-type: none"> 1. Press Select Photos ◀ or ▶ to display the photo you want to fix. 2. Press Menu. 3. Select Edit, then press OK. 4. Select Photo brightness, then press OK. 5. Use the Select Photos arrows to increase or decrease photo brightness to the desired level, then press OK.

(continued)

Problem	How to correct it
Blurred photos This preference affects all printed photos.	To automatically focus images for clearer, sharper detail <ol style="list-style-type: none">1. Press Menu.2. Select Preferences, then press OK.3. Select SmartFocus, then press OK.4. Select On, then press OK.
Photos with poor lighting and contrast This preference affects all printed photos.	To apply adaptive lighting to a photo <ol style="list-style-type: none">1. Press Menu.2. Select Preferences, then press OK.3. Select Adaptive Lighting, then press OK.4. Select On, then press OK.
Poor-quality video clips This preference photos printed from video clips. Note This feature does not improve photos printed using the Video action prints . This feature also does not work with photos printed in the 9-per-page layout.	For information about printing photos from video clips, see Printing photos from a memory card . To improve the quality of photos printed from video clips <ol style="list-style-type: none">1. Press Menu.2. Select Preferences, then press OK.3. Select Video enhancement, then press OK.4. Select On, then press OK.

Getting creative

The printer provides a variety of tools and effects that let you use your photos in creative ways. These print settings do not change the original photo. They only affect printing.

To try these features...	Follow these steps
Add a color effect You can set the printer to print a selected photo in Black & white , or with a Red filter , Blue filter , or Green filter . For brown tones that look similar to photos produced in the early 1900s, use Sepia or Antique . Use Antique for a hand-colored appearance. Use Solarize to give a darkroom look. Use Metallic to give light colors a metallic look.	<ol style="list-style-type: none">1. Press Select Photos ◀ or ▶ to display the photo to which you want to add a color effect.2. Press Menu.3. Select Edit, then press OK.4. Select Add color effect, then press OK.5. Select a color effect, then press OK. The photo appears on the printer screen with the selected color effect applied. The effect does not change the original photo. It only affects printing.

(continued)

To try these features...	Follow these steps
<p>Create borderless prints</p> <p>You can set the printer to print borderless photos.</p>	<ol style="list-style-type: none"> 1. Press Layout. 2. Select One photo per sheet, borderless, then press OK. <p>Make sure to use photo paper. If you use plain paper, the printer will override the borderless setting and print with narrow white borders on all sides to prevent paper jams.</p>
<p>Add a decorative frame</p> <p>Choose from a palette of different patterns and colors to make the frame stand out.</p>	<ol style="list-style-type: none"> 1. Press Select Photos ◀ or ▶ to display the photo to which you want to add a frame. 2. Press Menu. 3. Select Edit, then press OK. 4. Select Add frame, then select OK. 5. Use the Select Photos arrows to highlight the frame pattern you want to use, then press OK. 6. Use the Select Photos arrows to highlight the frame color you want to use, then press OK. The photo appears on the printer screen with the frame.
<p>Add the date and time to your prints</p> <p>You can print a stamp on the front of your photos that shows when the photo was taken. This preference affects all prints.</p> <p>Changes that you make to the photo using the printer control panel do not affect the date and time information.</p>	<ol style="list-style-type: none"> 1. Press Menu. 2. Select Preferences, then press OK. 3. Select Date/time, then press OK. 4. Select one of the following date/time stamp options: <ul style="list-style-type: none"> – Date/time – Date only 5. Press OK.
<p>Change the print quality</p> <p>You can change the print quality for photos. Best quality is the default and produces the highest quality photos. Normal quality conserves ink and prints faster.</p>	<p>To change the print quality to Normal for one print job</p> <ol style="list-style-type: none"> 1. Press Menu. 2. Select Tools, then press OK. 3. Select Print quality, then press OK. 4. Select Normal, then press OK. <p>Print quality will revert to Best after this print job.</p>
<p>View a slide show</p> <p>You can view all the photos stored on a memory card in sequence like a slide show.</p>	<p>To view a slide show on the printer screen</p> <ol style="list-style-type: none"> 1. Press Menu. 2. Select Tools, then press OK. 3. Select Slide Show, then press OK. Press OK to pause or resume a slide show. Press Cancel to stop the slide show.
<p>Crop a photo</p>	<ol style="list-style-type: none"> 1. Press Select Photos ◀ or ▶ to display the photo you want to crop.

(continued)

To try these features...	Follow these steps
<p>Press Zoom to enter Zoom mode, where you can increase or decrease the magnification by 0.25x. The maximum level is 5.0x.</p> <p>Note The crop box changes from green to yellow if printing at the selected magnification will noticeably reduce the print quality.</p>	<ol style="list-style-type: none">2. Press Zoom to enter Zoom mode and increase the magnification of the photo by 0.25x.3. Press Select Photos ► to increase the magnification level by 0.25x. Press Select Photos ◀ to decrease the magnification level by 0.25x. The minimum magnification level is 1.0x.4. At any magnification level, use the Select Photos arrows to move the crop box left, right, up, or down.5. Press OK when the portion of the image you want to print is in the crop box.
<p>Print panoramic photos</p> <p>Note All photos printed in panoramic mode are printed borderless.</p>	<ol style="list-style-type: none">1. Press Menu.2. Select Print options, then press OK.3. Select Print panoramic photos.4. Select On, then press OK. The top of the printer screen displays Panoramic mode until you turn it off in the menu.5. Load 10 x 30 cm (4 x 12 inch) media. If desired, use the instructions described above for cropping a photo before printing. The crop box has a 3:1 aspect ratio.
<p>Print stickers</p> <p>Load Avery C6611 or C6612 photo sticker paper before printing. This 10 x 15 cm (4 x 6 inch) paper has 16 rectangular or oval stickers per page.</p>	<ol style="list-style-type: none">1. Press Menu.2. Select Print options, then press OK.3. Select Print stickers, then press OK.4. Select On, then press OK. The top of the printer screen displays Sticker mode until you turn it off in the menu.

Printing photos from a digital camera

You can print photos by connecting an HP direct-printing digital camera or a PictBridge-compatible digital camera directly to the printer with a USB cable. If you have a Bluetooth-compatible digital camera, you can insert the optional HP Bluetooth wireless printer adapter in the printer and send photos to the printer wirelessly.

When you print from a digital camera, the printer uses the settings that you selected on the camera. For more information, see the documentation that came with the camera.

To print photos from a...	Follow these steps
<p>Digital camera with Bluetooth wireless technology</p>	<ol style="list-style-type: none">1. Set the Bluetooth options for the printer using the Bluetooth menu on the printer screen. For more information, see Printer menu.

(continued)

To print photos from a...	Follow these steps
<p>If you have a Bluetooth digital camera, you can purchase the optional HP Bluetooth wireless printer adapter and print from the camera using a Bluetooth wireless connection.</p> <p>Note For information on how to print from other Bluetooth wireless devices, see Printing without a computer.</p>	<ol style="list-style-type: none"> 2. Load photo paper in the printer. For information, see Loading paper. 3. Insert the HP Bluetooth wireless printer adapter into the camera port on the front of the printer. The light on the adapter will flash when the adapter is ready to receive data. 4. Follow the instructions in the documentation that came with the digital camera to send photos to the printer.
<p>Digital camera with PictBridge technology</p> <p>Note Some PictBridge cameras might list the 5 x 7 inch paper size as 2L, 127 x 178 mm, or 13 x 18 cm.</p>	<ol style="list-style-type: none"> 1. Turn on the PictBridge-compatible digital camera and select the photos you want to print. 2. Load photo paper in the printer. 3. Make sure the camera is in PictBridge mode, then connect it to the camera port on the front of the printer using the USB cable that came with the camera. Once the printer recognizes the PictBridge-compatible camera, the selected photos print automatically.
<p>HP direct-printing digital camera</p>	<ol style="list-style-type: none"> 1. Turn on the HP direct-printing digital camera and select the photos you want to print. 2. Connect the camera to the USB port on the back of the printer using the USB cable that came with the camera. 3. Load photo paper in the printer. Use the Photo cassette for smaller photo paper sizes. 4. Follow the instructions on the camera screen.

Printing photos from other Bluetooth devices

You can also print from other devices with Bluetooth wireless technology, such as PDAs, notebook computers, and mobile phones. For more information, see [Getting connected](#), the onscreen HP Photosmart Printer Help, and the documentation that came with the Bluetooth device.



Note To use Bluetooth connectivity, all devices must have the necessary hardware and software installed. In addition, an HP Bluetooth wireless printer adapter must be connected to the camera port on the front of the printer.

The basic procedure for printing from any Bluetooth device is the same:

1. Have the device search for available Bluetooth printers.
2. Select the printer when it appears on the device.
3. Print.

Check the documentation that came with the device for detailed instructions.

Printing photos from an HP iPod

Before using the steps below to import photos to and print photos from your HP iPod, make sure your images and your HP iPod meet the following requirements:

- The images you copy to the HP iPod must be in JPEG format.
- Make sure the HP iPod is formatted in Windows (FAT 32 file structure). The HP iPod defaults to the Windows file structure. To check if your HP iPod was formatted for Windows, go to **Settings > About** on your HP iPod. If it was formatted in Windows, it will display **Format Windows** at the bottom of the screen. If it was not formatted in Windows, you must connect the HP iPod to a Windows PC using the USB cable that came with the HP iPod and follow the onscreen instructions.



Note 1 HP iPods that have only been connected to a Macintosh are not compatible with the printer; however, you can connect the HP iPod to a Windows PC to make it compatible. After connecting to a Windows PC, Macintosh users can still fully synchronize their HP iPods back to Macintosh and Mac iTunes and maintain printer support.

Note 2 HP iPods might not be available in your country/region.

To import photos to an HP iPod

1. Copy photos from a memory card to your HP iPod using the Belkin Media Reader for iPod.
2. Verify that photos are on your HP iPod by selecting **Photo Import** on the HP iPod menu. Photos appear as **Rolls**.

To print photos from an HP iPod

1. Connect the HP iPod to the camera port on the **front** of the printer using the USB cable that came with the HP iPod. The printer screen displays **Reading Device** for several minutes while the photos are read. Then the photos appear on the printer screen.
2. Select the photo(s) you want to print and press **Print**. For more information on selecting and printing photos, see [Selecting photos to print](#).

If you are unable to print to the HP Photosmart printer using your HP iPod, please contact HP Customer Care. See [HP Customer Care](#).

4 Printing from a computer

All HP photo printers come with the HP Image Zone software, which helps you do more with your photos than ever before. Use it to get creative with your pictures: edit them, share them, and create fun projects such as greeting cards.

The HP Photosmart printer software interface appears whenever you print. It controls the resolution and color, and it usually chooses those settings automatically. If you are printing a digital photo, adjust the printer software settings to produce the best-quality print.

Be sure to download the latest printer software update every couple of months to ensure you have the latest features and improvements. For more information, see [Updating the software](#).

Using creative options in the printer software

Read through these tips on how to open and use HP Image Zone, HP Image Zone Express, and HP Instant Share.

HP Image Zone

HP Image Zone is an easy-to-use software program that gives you everything you need to have fun with your photos, in addition to basic photo editing and printing. This software also gives you access to HP Instant Share so that you can easily share your photos.

Open HP Image Zone (Windows users)

→ Double-click the **HP Image Zone** icon on your desktop. If you need help, see the onscreen Help within HP Image Zone.

Open HP Image Zone (Macintosh users)

→ Click the **HP Image Zone** icon in the Dock. If you need help, select **HP Image Zone Help** from the **Help** menu.

Explore the many features of HP Image Zone:

- **View** — View photos in multiple sizes and ways. Easily organize and manage your photos.
- **Edit** — Crop your photos and fix photos with red eye. Automatically adjust and enhance your photos in different sizes and in multiple layouts.
- **Print** — Print your photos in different sizes and in multiple layouts.
- **Share** — Send photos to family and friends without the bulky attachments using HP Instant Share, a better way to send e-mail.
- **Create** — Easily create album pages, cards, calendars, panoramic photos, CD labels, and more.
- **Back-up** — Make back-up copies of your photos to store and save.

HP Image Zone Express

HP Image Zone Express is an easy-to-use software program that gives you basic photo editing and printing capabilities. This software also gives you access to

HP Instant Share so that you can easily share your photos. HP Image Zone Express is only available for Windows users.

Open HP Image Zone Express (Windows users)

→ Double-click the **HP Image Zone Express** icon on your desktop. If you need help, see the onscreen Help within HP Image Zone Express.

Explore the many features of HP Image Zone Express:

- **View** — View photos in multiple sizes and ways. Easily organize and manage your photos.
- **Edit** — Crop your photos and fix photos with red eye. Automatically adjust and enhance your photos to make them perfect.
- **Print** — Print your photos in different sizes and in multiple layouts.
- **Share** — Send photos to family and friends without the bulky attachments with HP Instant Share, a better way to send e-mail.

HP Instant Share

HP Instant Share allows you to send photos to family and friends without bulky e-mail attachments. The printer must be connected through a USB cable to a computer with Internet access and have all the HP software installed. For more information, see the HP Image Zone or HP Image Zone Express onscreen Help.

Open HP Instant Share (Windows users)

→ Click the **HP Instant Share** tab within HP Image Zone or HP Image Zone Express.

Open HP Instant Share (Macintosh users)

→ Click the **Applications** tab in HP Image Zone, then double-click **HP Instant Share**.

5 Care and maintenance

The HP Photosmart 8000 series printer requires very little maintenance. Follow the guidelines in this chapter to extend the life span of the printer and printing supplies, and to ensure that the photos you print are always of the highest quality.

Cleaning and maintaining the printer

Keep the printer and print cartridges clean and well maintained using the simple procedures in this section.

Cleaning the outside of the printer

To clean the exterior of the printer

1. Turn off the printer, then disconnect the power cord from the back of the printer.
2. Wipe the outside of the printer with a soft cloth that has been lightly moistened with water.



Caution Do not use any type of cleaning solution. Household cleaners and detergents may damage the printer finish. Do not clean the interior of the printer. Keep all fluids away from the interior. Do not lubricate the metal rod on which the print cartridge cradle slides. Noise is normal when the cradle moves back and forth.

Automatically cleaning the print cartridges

If you notice white lines or single-color streaks on the photos you print, the print cartridges may need to be cleaned. Do not clean the cartridges more often than necessary, since cleaning uses up ink. Follow the steps in this section to run an automatic cartridge-cleaning procedure.

To automatically clean the print cartridges

1. Press **Menu**.
2. Select **Tools**, then press **OK**.
3. Select **Clean cartridges**, then press **OK**.
4. Following the directions on the printer screen, load paper so the printer can print a test page after cleaning the cartridges. Use plain paper to conserve photo paper.
5. Press **OK** to begin cleaning the print cartridges.
6. When the printer finishes cleaning the cartridges and prints a test page, it asks whether you want to **Continue to second level cleaning**. Check the test page and select from the following options:
 - If the test page has white streaks or missing colors, the print cartridges need to be cleaned again. Select **Yes**, then press **OK** to continue to a second level cleaning.
 - If the print quality of the test page looks good, select **No**, then press **OK**.

You can clean the cartridges up to three times. Each successive cleaning is more thorough and uses more ink.

If you complete all three levels of cleaning using this procedure and you still notice white streaks or missing colors on the test page, you may need to clean the print cartridge contacts. For more information, see [Manually cleaning the print cartridge contacts](#).



Note If a cartridge has been recently dropped, you may also see white streaks or missing colors in your prints. This problem is temporary and clears up within 24 hours.

Manually cleaning the print cartridge contacts

If you use the printer in a dusty environment, debris may accumulate on the copper-colored contacts and cause printing problems.

To clean the print cartridge contacts

1. Gather the following items to clean the contacts:
 - Distilled water (tap water may contain contaminants that can damage the print cartridge)
 - Cotton swabs or other soft, lint-free material that will not stick to the print cartridge
2. Open the main cover of the printer.
3. Remove the print cartridge and place it on a piece of paper with the ink nozzle plate facing up. Be careful not to touch the copper-colored contacts or the ink nozzle plate with your fingers.



Caution Do not leave the print cartridge outside the printer for more than 30 minutes. Ink nozzles exposed to the air longer than this may dry out and cause printing problems.

4. Lightly moisten a cotton swab with distilled water and squeeze any excess water from the swab.
5. Gently wipe the copper-colored contacts with the cotton swab.



Caution Do not touch the ink nozzle plate. Touching the ink nozzle plate will result in clogs, ink failure, and bad electrical connections.

6. Repeat steps 4 and 5 until no ink residue or dust appears on a clean swab.
7. Insert the print cartridge in the printer, then close the main cover.

Printing a test page

You can print a test page to check the condition of the print cartridge.

1. Press **Menu**.
2. Select **Tools**, then press **OK**.
3. Select **Print test page**, then press **OK**.
4. Following the directions on the printer screen, load paper so the printer can print a test page. Use plain paper to conserve photo paper.
5. Press **OK** to begin printing the test page.

The test page contains the following information:

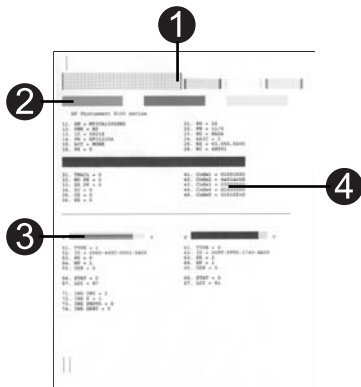

- | | |
|---|--|
| 1 | Image print quality. If the lined bars look good, photos should print well. |
| 2 | Ink nozzle quality. If there are white streaks in the solid bars on this page, try cleaning the print cartridge. |
| 3 | Estimated ink level. This indicator shows how much ink is left in the print cartridge. |
| 4 | Diagnostic information. Use the text information on this page when working with Customer Care to solve printing problems. |

Aligning the print cartridges

The first time you install a print cartridge in the printer, the printer aligns it automatically. However, if colors in the photos you print are misaligned, or if the alignment page does not print correctly when you install a new print cartridge, use the following procedure to align the print cartridges.

To align the print cartridges

1. Press **Menu**.
2. Select **Tools**, then press **OK**.
3. Select **Align cartridge**.
4. Following the directions on the printer screen, load paper so the printer can print an alignment page. Use plain paper to conserve photo paper.
5. Press **OK** to begin aligning the print cartridge.
When the printer finishes aligning the cartridge, it prints an alignment page to confirm that the alignment was successful.
 - The check marks verify that the print cartridge is installed correctly and functioning properly.
 - If an “x” appears to the left of any of the bars, align the print cartridge again. If the “x” still appears, replace the print cartridge.

Printing a sample page

You can print a sample page to test the printer photo printing quality and to make sure the paper is loaded correctly.

1. Load paper in the Main tray. Use plain paper to conserve photo paper.
2. Press **Menu**.
3. Select **Tools**, then press **OK**.
4. Select **Print sample page**, then press **OK**.

Updating the software

Download the latest printer software update periodically to ensure you have the latest features and improvements. To download printer software updates, visit www.hp.com/support or use **HP Software Update**. Make sure the computer is connected to the Internet before performing software updates.



Note These procedures do not update the HP Image Zone software. In some countries/regions, you can contact HP directly to order HP Image Zone software updates on CD.

Downloading the software (Windows users)

1. From the Windows **Start** menu, select **Programs (All Programs in Windows® XP) > HP > HP Software Update**.
2. Click **Next**. HP Software Update searches the HP website for printer software updates. If the computer does not have the most recent version of the printer software installed, a software update appears in the **HP Software Update** window. If the computer has the most recent version of the printer software installed, **No new updates are available** appears in the **HP Software Update** window.
3. If a software update is available, check the box beside the update to select it.
4. Click **Next**.
5. Follow the onscreen instructions.

Downloading the software (Macintosh users)

1. Click **HP Image Zone** in the Dock.
2. Click the **Applications** tab.
3. Click **HP Software Update**.
4. Follow the onscreen instructions to check for software updates.
If you are behind a firewall, you need to enter the proxy server information in the updater.

Storing the printer and print cartridges

Protect the printer and print cartridges by storing them properly when you are not using them.

Storing the printer

For safe and convenient storage of the printer, the Main and Output trays fold up into the printer. You can store the paper trays by following these steps:

1. Turn off the printer.
2. Remove all paper from the paper trays.
3. If the Output tray extender is extended, push it in.
4. Lift and fold up the Output tray.
5. Lift and fold up the Main tray until it snaps into place.

The printer is built to withstand long or short periods of inactivity.

- Store the printer indoors out of direct sunlight in a place without temperature extremes.
- If the printer and print cartridge have not been used for one month or more, clean the print cartridges before printing. For more information, see [Cleaning and maintaining the printer](#).

Storing the print cartridges

When you store the printer, always leave the active print cartridges inside the printer. The printer stores the print cartridges in a protective cap during the power-down cycle.



Caution Make sure the printer completes its power-down cycle before you unplug the power cord. This allows the printer to store the print cartridges properly.

Follow these tips to help maintain HP print cartridges and ensure consistent print quality:

- When you remove a print cartridge from the printer, store it in a print cartridge protector to prevent the ink from drying out.
In some countries/regions the cartridge protector is not included with the printer, but comes with the HP Gray Photo cartridge that can be purchased separately. In other countries/regions, the protector is included with the printer.
- Keep all unused print cartridges in their original sealed packages until they are needed. Store print cartridges at room temperature (15–35 degrees C or 59–95 degrees F).
- Do not remove the plastic tape covering the ink nozzles until you are ready to install the print cartridge in the printer. If the plastic tape has been removed from the print cartridge, do not attempt to reattach it. Reattaching the tape damages the print cartridge.

Maintaining the quality of photo paper

For best results with photo paper, follow the guidelines in this section.

Storing photo paper

- Store the photo paper in its original packaging or in a resealable plastic bag.
- Store the packaged photo paper on a flat, cool, and dry surface.
- Return unused photo paper to its original packaging or in a resealable plastic bag. Paper left in the printer or exposed to the environment may curl or yellow.

Handling photo paper

- Always hold photo paper by the edges to avoid fingerprints.
- If the photo paper has curled edges, place it in its plastic storage bag and gently bend it in the opposite direction of the curl until the paper lies flat.

6 Troubleshooting

The HP Photosmart printer is designed to be reliable and easy to use. This chapter answers frequently asked questions about using the printer and printing without a computer. It contains information about the following topics:

- [Printer hardware problems](#)
- [Printing problems](#)
- [Error messages](#)
- [Bluetooth printing problems](#)

For additional troubleshooting information, see:

- **Software installation troubleshooting:** The *Quick Start* booklet that came with the printer.
- **Printer software and printing from a computer troubleshooting:** The onscreen HP Photosmart Printer Help. For information about viewing the onscreen Printer Help, see [Welcome](#).

Printer hardware problems

Before contacting Customer Care, read this section for troubleshooting tips or go to the online support services at www.hp.com/support.



Note If you want to connect the printer to a computer with a USB cable, HP recommends using a cable of less than 3 meters (10 feet) in length to minimize injected noise due to potential high electromagnetic fields.

The Print light is pulsing green but the printer is not printing.

Solution The printer is busy processing information. Wait for it to finish.

The Status light is flashing red.

Solution

The printer requires attention. Try the following:

- Check the printer screen for instructions. If you have a digital camera connected to the printer, check the camera screen for instructions.
- If the printer is not connected to a computer, check for the following problems:
 - Main cover open
 - Out of paper
 - Paper jam
 - Print carriage jammed or stuck
 - Print cartridge missing or inserted incorrectly
 - Print cartridge tape not removed

- Incorrect print cartridge installed
 - Packaging materials are not removed
 - If you are unable to solve the problem by using the instructions above, turn off the printer, then unplug the power cord. Wait about 10 seconds, then plug it in again. Turn on the printer.
-

The Status light flashed amber briefly after I turned the printer off.

Solution This is a normal part of the power-down process. It does not indicate a problem with the printer.

The Status light is flashing amber.

Solution

A printer error has occurred. Try the following:

- Check the printer screen for instructions. If you have a digital camera connected to the printer, check the camera screen for instructions. If the printer is connected to a computer, check the computer monitor for instructions.
 - Turn off the printer, then unplug the power cord. Wait about 10 seconds, then plug it in again. Turn on the printer.
 - If the Status light continues to flash amber, go to www.hp.com/support or contact Customer Care.
-

The printer does not find and display the photos I stored on my memory card.

Solution

Try the following:

- Turn off the printer, then unplug the power cord. Wait about 10 seconds, then plug it in again. Turn on the printer.
 - The memory card may contain file types the printer cannot read directly from the memory card.
 - Save the photos to a computer, then print them from the computer. For more information, see the documentation that came with the camera and the onscreen HP Photosmart Printer Help.
 - The next time you take photos, set the digital camera to save them in a file format the printer can read directly from the memory card. For a list of supported file formats, see [Specifications](#). For instructions on setting the digital camera to save photos in specific file formats, see the documentation that came with the camera.
 - The memory card may need to be reformatted if the problem persists.
-

The printer makes noises when I turn it on, or starts making noises on its own after it has been sitting unused for a while.

Solution The printer may make noises after long periods of inactivity (approximately 2 weeks), or when its power supply has been interrupted and then restored. This is normal operation—the printer is performing an automatic maintenance procedure to ensure that it produces the best quality output.

The printer is plugged in, but it will not turn on.

Solution

- The printer may have drawn too much power. Unplug the printer power cord. Wait about 10 seconds, then plug the power cord back in. Turn on the printer.
 - The printer may be plugged into a power strip that is turned off. Turn on the power strip, then turn on the printer.
-

Printing problems

Before contacting Customer Care, read this section for troubleshooting tips or go to the online support services at www.hp.com/support.

The printer does not print borderless photos when I print from the control panel.

Solution

Make sure you have selected an appropriate paper size. The printer cannot print borderless photos on all sizes of paper. For information about selecting the paper size for borderless photos, see [Choosing the right paper](#).

Printing is very slow.

Solution

- You may be printing a project containing a high-resolution graphic, a high-resolution photo, or a PDF. Large, complex projects containing graphics or photos print slower than text documents.
 - The printer may be in Ink-backup Printing Mode. The printer enters this mode when one of the print cartridges has been removed. Replace the missing print cartridge.
-

I selected the **Print new option in the printer menu, and got more photos than I expected.**

Solution To the printer, a “new” photo on a memory card is one that you haven’t printed from the printer control panel. When you select **Print new**, the printer will print all photos that have not previously been printed from the control

panel. To print the photos you want, select them manually. For more information, see [Selecting photos to print](#).

I selected the [Print new](#) option in the printer menu, but the printer did not print the new photos stored on the memory card.

Solution There are no new photos on the memory card, or the photos have already been printed from the printer control panel. To print the photos you want, select them manually. For more information, see [Selecting photos to print](#).

Photo paper does not feed into the printer correctly from the Photo cassette.

Solution

- If you are using the Photo cassette for printing, there may be paper loaded in the Main tray. Remove any paper from the Main tray before inserting the Photo cassette for printing.
 - The Photo cassette paper guides may not be adjusted correctly. Make sure that the Photo cassette paper-width guide and the paper-length guide fit close to the edges of the paper without bending the paper.
 - The Photo cassette may not be engaged. Insert the Photo cassette until it snaps into place. For more information about loading the Photo cassette, see [Loading your paper](#).
 - The printer may be in an extremely high- or low- humidity environment. Load one sheet of photo paper at a time.
 - The paper you are trying to load might be too large for the Photo cassette. For a list of sizes that you can use with the Photo cassette, see [Loading your paper](#).
 - The photo paper may be curled. If the photo paper is curled, place the paper in a plastic bag and gently bend it the opposite direction of the curl until the paper lies flat. If the problem persists, then use photo paper that is not curled.
-

Paper does not feed into the printer correctly from the Main tray.

Solution

- There may be too much paper loaded in the Main tray. Remove some paper from the tray and try printing again.
- The paper guides may not be adjusted correctly. Make sure that the paper-width guide and the paper-length guide fit close to the edges of the paper without bending the paper.
- Two or more pieces of paper may be sticking together. Remove the paper from the Main tray, fan the edges of the stack to separate the sheets of paper, then reload the paper and try printing again.
- If the paper is wrinkled or bent, try using different paper.

- If you are loading small photo paper, use the Photo cassette. For a list of sizes that you can place in the Main tray and Photo cassette, see [Loading your paper](#).
 - The paper may be too thin or too thick. Use HP paper for best results. For more information, see [Choosing the right paper](#).
-

Printed pages are dropping off of the Output tray.

Solution Pages can drop off of the Output tray when they are printed. To prevent this, always extend the Output tray extension when you print.

The printout is rippled or curled.

Solution The project you are printing uses a larger amount of ink than normal. Print the project from a computer, and use the printer software to lower the ink saturation level. See the onscreen HP Photosmart Printer Help for more information.

The document printed at an angle or is off-center.

Solution

- The paper may not be loaded correctly. Reload the paper, make sure that the paper is correctly oriented in the Main tray, and that the paper-width guide and the paper-length guide fit close to the edges of the paper. For paper-loading instructions, see [Loading your paper](#).
 - The photo paper may not be loaded correctly. Reload the photo paper, make sure that the photo paper is correctly oriented in the Photo cassette, and that the paper-width guide and the paper-length guide fit close to the edges of the photo paper. Load the Photo cassette into the Main tray. For photo paper-loading instructions, see [Loading your paper](#).
 - The print cartridges may need to be aligned. For more information, see [Aligning the print cartridges](#).
-

Colors are not printing satisfactorily.

Solution

- You may not be using the best print cartridges for the project. To print text documents and graphics, use the HP Tri-color and HP Black print cartridges. To print color photos, use the HP Tri-color and HP Photo or HP Gray Photo cartridges. For more information, see [Inserting and replacing the print cartridges](#).
- You may be printing in Ink-backup Printing Mode. The printer enters Ink-backup printing mode when one of the print cartridges is missing. Replace the missing cartridge.

- A cartridge is out of ink. Replace it.
 - Some of the ink nozzles on a cartridge are clogged. Clean the cartridges. See [Cleaning and maintaining the printer](#).
-

No page came out of the printer. —OR— The paper jammed while printing.

Solution

- The printer may need attention. Read the printer screen for instructions.
 - The power may be off or there may be a loose connection. Make sure the power is on, and that the power cord is securely connected.
 - You may not have any paper in the Main tray or Photo cassette. Check that the paper is loaded correctly. For paper-loading instructions, see [Loading your paper](#).
 - The paper may have jammed while printing.
 - Turn off the printer, then unplug it from the power source. Clear the printer of any paper that may be obstructing the paper path. For more information, see [To clear a paper jam](#).
 - If you were printing labels, make sure a label did not become unglued from the label sheet while going through the printer.
 - If you experience paper jams when using the Photo cassette, make sure that the photo paper-width guide and the photo paper-length guide fit close to the edges of the photo paper without bending the paper. Make sure the Photo cassette is fully engaged by gently pushing the Photo cassette toward the printer until it stops. If you still have problems, try loading one sheet of photo paper at a time.
-

A blank page came out of the printer.

Solution

- You may have begun printing and then cancelled the process. If you cancelled the process before printing started, the printer may have already loaded paper in preparation for printing. The next time you print, the printer will eject the blank page before starting the new printing project.
 - Check the ink-level icons on the printer screen. Replace any print cartridges that are out of ink. For more information, see [Inserting and replacing the print cartridges](#).
 - If you are trying to print a fax, first save the fax in a graphic format such as TIFF. Place it in a word processing document and print it from there.
-

The photo did not print using the printer default print settings.

Solution You may have changed the print settings for the selected photo. Print settings you apply to an individual photo override the printer default print settings. Discard all print settings that have been applied to an individual photo by deselecting the photo. For more information, see [Selecting photos to print](#).

The printer ejects the paper when preparing to print.

Solution Direct sunlight could be interfering with the operation of the automatic paper sensor. Move the printer out of direct sunlight.

Print quality is poor.

Solution

- You may be printing in Ink-backup Printing Mode. The printer enters Ink-backup Printing Mode when one of the print cartridges is missing. Replace the missing print cartridge with a new one. For more information, see [Inserting and replacing the print cartridges](#).
 - If you magnified the photo using the **Zoom** button on the printer control panel, you may have magnified the photo too much. To reduce the magnification, press **Zoom** to enter Zoom mode, and then press **Select Photos** ◀ one or more times to reduce the magnification.
 - One of the print cartridges may be running out of ink. If a print cartridge is running low on ink, replace it. For more information, see [Inserting and replacing the print cartridges](#).
 - Use photo paper designed for the printer. For best results, use HP paper.
 - You may be printing on the wrong side of the paper. Make sure the paper is loaded with the side to be printed facing down.
 - You may have selected a low-resolution setting on the digital camera. Reduce the size of the image and try printing again. For better results in the future, set the digital camera to a higher photo resolution.
 - There may be a problem with a print cartridge. Try the following:
 - Remove and then reinsert the print cartridges.
 - Run an automatic print cartridge cleaning procedure from the printer control panel. For more information, see [Cleaning and maintaining the printer](#).
 - Align the print cartridges from the printer control panel. For more information, see [Aligning the print cartridges](#).
 - If this does not solve the problem, try cleaning the copper-colored contacts on the print cartridges. For more information, see [Manually cleaning the print cartridge contacts](#).
 - If these solutions do not work, replace the print cartridge(s).
-

Printed photos are not fitting to the paper as desired.

Solution

- You may have loaded the photo paper incorrectly. Load the photo paper with the side to be printed facing down.
- The photo paper may not have fed into the printer correctly. Try the following:
 - If you have a paper jam, see [To clear a paper jam](#).
 - Load one sheet of photo paper at a time.
- You may have selected the wrong layout. For information, see [Selecting a photo layout](#).

- You may have chosen the wrong paper size for the selected layout. For information, see [Selecting a photo layout](#)
- See the HP Photosmart online printer help for information on how to optimize photo quality.

The photos I marked for printing in the digital camera do not print.

Solution Some digital cameras, such as the HP 318 and HP 612, let you mark photos for printing in both the camera's internal memory and on the memory card. If you mark photos in the internal memory, and then move photos from the camera's internal memory to the memory card, the marks do not transfer. Mark photos for printing after you transfer them from the digital camera's internal memory to the memory card.

Error messages

Before contacting Customer Care, read this section for troubleshooting tips or go to the online support services at www.hp.com/support.

Error messages that appear on the printer screen can be divided into the following types:

- Paper errors
- Print cartridge errors
- Memory card errors
- Proof sheet errors

Paper errors

Before contacting Customer Care, read this section for troubleshooting tips or go to the online support services at www.hp.com/support.

Error message: Paper jam. Clear jam then press OK.

Solution



Caution Do NOT remove jammed paper from the front of the printer. Doing so can cause irreversible damage to the printer.

To clear a paper jam

1. Turn off the printer, and then unplug the printer.
2. Remove the rear access door.

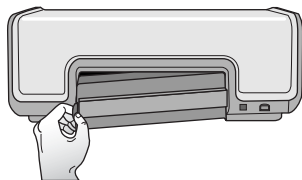

3. Gently remove the jammed paper from the printer.
 4. Replace the rear access door.
 5. Plug in the printer and turn it on.
 6. When you have cleared the paper jam, print your document again.
-

Error message: Out of paper. Load paper then press OK.

Solution Load paper, then press **OK** to print again. For paper-loading instructions, see [Loading paper](#).

Error message: Unsupported media size. Job was cancelled. Press OK.

Solution The printer cannot use the size of paper loaded. Press **OK**, then load a supported paper size instead. For a list of supported paper sizes, see [Printer specifications](#).

Error message: Automatic paper sensor failed.

Solution The automatic paper sensor is obstructed or damaged. Try moving the printer out of direct sunlight, then press **OK** and try printing again. If this does not work, go to www.hp.com/support or contact Customer Care.

Print cartridge errors

Before contacting Customer Care, read this section for troubleshooting tips or go to the online support services at www.hp.com/support.

Error message: Cartridge failed.

Solution The specified print cartridge may be old or damaged. Try the following:

1. Remove the cartridge and then reinstall it. For more information, see [Inserting and replacing the print cartridges](#).
 2. If this does not work, replace the cartridge.
-

Error message: Cartridge failed. Replace it, or remove it to print using ink-backup printing mode.

Solution The specified print cartridge may be old or damaged. Try the following:

1. Remove the cartridge and then reinstall it. For more information, see [Inserting and replacing the print cartridges](#).
 2. If this does not work, replace the cartridge. You can also print in Ink-backup Printing Mode by removing the damaged cartridge.
-

Error message: Cartridge not compatible.

Solution You have inserted a print cartridge that does not work with the printer. Replace the print cartridge with one that is compatible with the printer. For more information, see the back cover of this guide.

Error message: All print cartridges are missing.

Solution The print cartridges are either not installed or are installed incorrectly. Install the print cartridges using the instructions in [Inserting and replacing the print cartridges](#).

Error message: Ink is low.

Solution The specified print cartridge is low on ink. Replace the print cartridge. For more information, see the back cover of this guide.

Error message: One or more cartridges have failed.

Solution One or more of the print cartridges have failed. Replace the failed cartridges with new HP print cartridges. For more information, see the back cover of this guide.

Error message: One or more cartridges are not compatible.

Solution One or more of the print cartridges are not HP print cartridges. Replace the non-HP print cartridges with supported HP print cartridges. For more information, see the back cover of this guide.

Error message: Print cartridge cradle is stuck. Clear jam then press OK.

Solution Follow these steps to clear any obstruction in the path of the print cartridge cradle:

1. Lift the main cover to access the print cartridges.
 2. Clear any obstruction in the cradle path.
 3. Close the main cover.
 4. Press **OK** to continue.
The current page will eject and the print job will continue on the next available sheet of paper.
-

Error message: Main cover is open.

Solution Close the main cover of the printer.

Memory card errors

Before contacting Customer Care, read this section for troubleshooting tips or go to the online support services at www.hp.com/support.

Error message: Photo is missing. —OR— Some photos are missing.

Solution The printer cannot read the file on the memory card or the file was accidentally deleted, or one or more files specified for the job are missing from the memory card. Try saving the photos to the computer using the digital camera rather than the memory card. If a photo is missing, you may have accidentally deleted the photo from the card.

Error message: Card access error.

Solution The printer cannot read the data on the memory card and cannot complete any current print or save jobs. The data may be corrupted or there may be a physical problem with the memory card. Try the following:

- Save the files to the computer and access them from there.
 - If this does not work, use a new memory card or reformat the memory card using the digital camera. Any photos on the memory card will be lost.
 - If this does not work, the photo files may be damaged or unreadable. Before you contact Customer Care, try another memory card to determine if it is the printer or the memory card that is failing.
-

Error message: Cannot print photos.

Solution More than 10 photos specified for a print job may be corrupt, missing, or are an unsupported file type. For information about supported file types, see [Printer specifications](#). Try the following:

- Try saving the photos to the computer using the digital camera rather than the memory card.
 - Save the files to the computer and print from the computer.
 - Print a photo index and reselect photos. For more information, see [Deciding which photos to print](#).
-

Error message: Card is locked. Cannot access card.

Solution The printer cannot read the memory card because the memory card is password protected. Follow these steps:

1. Remove the memory card from the printer.
 2. Insert the memory card in the device you originally used to store the password on the memory card.
 3. Remove the password from the memory card using the same software you used to store the password.
 4. Remove the memory card and reinsert it in the printer memory card slot.
 5. Try printing again.
-

Error message: Use only 1 card at a time. Please remove a memory card.

Solution The printer has two or more different types of memory cards inserted simultaneously or a memory card inserted and a digital camera connected to the

camera port at the same time. Remove memory cards or disconnect the camera until only one card is in the printer or one camera is connected.

Error message: Card was removed. Job was cancelled.

Solution You removed a memory card from the printer while it was busy printing a file from the memory card or saving files to the computer. Follow these steps:

1. Press **OK**.
2. Reinsert the memory card and print selected photos or saved files again. The memory card must remain inserted until the print or save job is complete.

To avoid damage to memory cards, do not remove them from the printer memory card slot while they are being accessed. For more information, see [Removing a memory card](#).

Error message: Cannot display this photo.

Solution The memory card contains image formats that the printer does not support or the file is corrupted. For a list of supported image formats, see [Specifications](#). Access photos using the computer.

Proof sheet errors

Before contacting Customer Care, read this section for troubleshooting tips or go to the online support services at www.hp.com/support.

Error message: Could not read proof sheet. Scan cancelled.

Solution The proof sheet is smeared or has stray marks. Print a new proof sheet. For more information, see [Deciding which photos to print](#).

Error message: Can not detect the proof sheet. Scan cancelled.

Solution You may have loaded the proof sheet with the printed side facing up. Follow these steps:

1. Insert the proof sheet into the Main tray with the printed side facing down.
 2. Try scanning again. For more information, see [Selecting photos to print](#).
-

Error message: Multiple number of copies selected. Scan cancelled.

Solution You filled in more than one circle for the number of copies at the bottom of the proof sheet. The layout you select applies to each photo selected on the proof sheet. Print a new proof sheet and try again. For more information, see [Deciding which photos to print](#).

Error message: Multiple layouts selected. Scan cancelled.

Solution You filled in more than one layout circle at the bottom of the proof sheet. Follow these steps:

1. Print a new proof sheet.
 2. Completely fill in the circle to select one of the seven layouts.
 3. Try scanning the proof sheet again. For more information, see [Selecting photos to print](#).
-

Error message: Layout not selected.

Solution You have not filled in a layout circle at the bottom of the proof sheet beneath the layout you want to use for the photos. Completely fill in the circle below one of the seven layout icons at the bottom of the proof sheet. The printer will print the photos using that layout.

Error message: No images selected.

Solution You have not filled in the circles on the proof sheet beneath the photos you want to print, or you may not have filled in the circles completely. Follow these steps:

- Follow the steps on the proof sheet to select the photos you want to print and try again. For more information, see [Selecting photos to print](#).
 - For best results, be sure to fill in the circles completely with a dark pen or Number 2 pencil.
-

Error message: Card contents do not match proof sheet. Scan cancelled.

Solution The card inserted is not the same card as the one you used to print the proof sheet. Remove the card and reinsert the card you used to print the proof sheet.

Bluetooth printing problems

Before contacting HP Customer Care, read this section, or go to the online support services at www.hp.com/support. Be sure to also read the documentation that came with your HP Bluetooth wireless printer adapter and your Bluetooth device.

My Bluetooth device cannot find the printer.

Solution

- Make sure the Bluetooth device is plugged into the camera port on the front of the printer. The light on the adapter flashes when the adapter is ready to receive data.
 - You may be too far from the printer. Move the Bluetooth device closer to the printer. The maximum recommended distance between the Bluetooth device and the printer is 10 meters (30 feet).
 - Make sure that your Bluetooth device is compatible with the printer. For more information, see [Specifications](#).
-

No page came out of the printer.

Solution The printer may not recognize the type of file sent by the Bluetooth device. For a list of supported file formats, see [Printer specifications](#).

Print quality is poor.

Solution The photo you printed may be low resolution. For better results, set the digital camera to a higher resolution. Photos taken with VGA-resolution cameras, such as those found in wireless phones, may not have high enough resolution to produce a high-quality print.

7 HP Customer Care



Note The name of HP support services may vary by country/region.

If you have a problem, follow these steps:

1. Check the documentation that came with the printer.
 - **Quick Start booklet:** The *HP Photosmart 8000 series Quick Start* booklet explains how to set up the printer and print your first photo.
 - **User's Guide:** The *User's Guide* is the book you are reading. This book describes the basic features of the printer, explains how to use the printer without connecting a computer, and contains hardware troubleshooting information.
 - **HP Photosmart Printer Help:** The onscreen HP Photosmart Printer Help describes how to use the printer with a computer and contains software troubleshooting information.
2. If you are unable to solve the problem using the information in the documentation, visit www.hp.com/support to do the following:
 - Access online support pages
 - Send HP an e-mail message for answers to your questions
 - Connect with an HP technician by using online chat
 - Check for software updatesSupport options and availability vary by product, country/region, and language.
3. **For Europe only:** Contact your local point of purchase. If the printer has a hardware failure, you will be asked to bring the printer to where you purchased it. Service is free during the printer limited warranty period. After the warranty period, you will be quoted a service charge.
4. If you are unable to solve the problem using the onscreen Help or HP websites, call Customer Care using the number for your country/region. For a list of country/region phone numbers, see [HP Customer Care by phone](#).

HP Customer Care by phone

While the printer is under warranty, you can obtain free phone support. For more information, see the warranty included in the box, or go to www.hp.com/support to check the duration of your free support.

After the free phone support period, you can obtain help from HP at an additional cost. Contact your HP dealer or call the support phone number for your country/region for support options.

To receive HP support by phone, call the appropriate support phone number for your location. Standard phone company charges apply.

North America: Call 1-800-474-6836 (1-800 HP invent). U.S. phone support is available in both English and Spanish languages 24 hours a day, 7 days a week (days and hours of support may change without notice). This service is free during the warranty period. A fee may apply outside the warranty period.

Western Europe: Customers in Austria, Belgium, Denmark, Spain, France, Germany, Ireland, Italy, Netherlands, Norway, Portugal, Finland, Sweden, Switzerland, and the United Kingdom should go to www.hp.com/support to access phone support numbers in their country/region.

Other countries/regions: See the list of support telephone numbers inside the front cover of this guide.

Placing a call

Call HP Customer Care while you are near the computer and printer. Be prepared to provide the following information:

- Printer model number (located on the front of the printer)
- Printer serial number (located on the bottom of the printer)
- Computer operating system
- Version of printer driver:
 - **Windows PC:** To see the printer driver version, right-click the Memory Card icon in the Windows taskbar and select **About**.
 - **Macintosh:** To see the printer driver version, use the Print dialog box.
- Messages displayed on the printer screen or on the computer monitor
- Answers to the following questions:
 - Has the situation you are calling about happened before? Can you recreate the situation?
 - Did you install any new hardware or software on your computer around the time that the situation occurred?

Return to HP repair service (North America only)

HP will arrange to have your product picked up and delivered to an HP Central Repair Center. We pay for the round-trip shipping and handling. This service is free for the duration of the hardware warranty period.

Additional warranty options

Extended service plans are available for the printer at additional costs. Go to www.hp.com/support, select your country/region and language, then explore the services and warranty area for information about the extended service plans.



Note This service might not be available in your country/region.

8 Specifications

This section lists the minimum system requirements for installing the printer software, and provides selected printer specifications.

For a complete list of printer specifications and system requirements, see the onscreen HP Photosmart Printer Help. For information about viewing the onscreen Help, see [Welcome](#).

System requirements

Component	Windows PC minimum	Macintosh minimum
Operating system	Microsoft® Windows 98, 2000 Professional, Me, XP Home, and XP Professional	Mac OS X 10.2 and greater
Processor	Intel® Pentium® II (or equivalent) or higher	G3 or greater
RAM	128 MB recommended	128 MB
Free disk space	500 MB	150 MB
Video display	800 x 600, 16-bit or higher	800 x 600, 16-bit or higher
CD-ROM drive	4x	4x
Connectivity	USB 2.0 full-speed: Microsoft Windows 98, 2000 Professional, Me, XP Home, and XP Professional PictBridge: using front camera port Bluetooth: using optional HP Bluetooth wireless printer adapter	USB 2.0 full-speed: Mac OS X 10.2 and greater PictBridge: using front camera port
Browser	Microsoft Internet Explorer 5.5 or later	—

Printer specifications

Category	Specifications
Media specifications	Recommended maximum length: 35.6 cm (14 inch) Recommended maximum thickness: 292 µm (11.5 mil)
Media sizes	Photo paper, 10 x 15 cm (4 x 6 inch) Photo paper with tab, 10 x 15 cm with 1.25 cm tab (4 x 6 inch with 0.5 inch tab) Photo paper, 13 x 18 cm (5 x 7 inch) Photo paper, 10 x 30 cm (4 x 12 inch) panorama Photo cards, 10 x 20 cm (4 x 8 inch) Index cards, 10 x 15 cm (4 x 6 inch) Hagaki cards, 10.0 x 14.8 cm (3.9 x 5.8 inch) A6 cards, 10.5 x 14.8 cm (4.1 x 5.8 inch) L-size cards, 9.0 x 12.7 cm (3.5 x 5 inch) L-size cards with tab, 9.0 x 12.7 cm with 1.25 cm tab (3.5 x 5 inch with 0.5 inch tab)
Media sizes supported	Supported sizes when printing from a computer 7.6 x 12.7 cm to 22 x 61 cm (3 x 5 inch to 8.5 x 24 inch) Supported sizes when printing from the control panel Metric: A6, A4, 10 x 15 cm (with and without tab); Imperial: 3.5 x 5 inch, 4 x 6 inch (with and without tab), 4 x 12 inch, 5 x 7 inch, 8 x 10 inch, 8.5 x 11 inch; Other: Hagaki and L-size
Media types supported	Paper (plain, inkjet, photo, and panoramic photo) Envelopes Transparencies Labels Cards (index, greeting, Hagaki, A6, L-size) Iron-on transfers Avery C6611 and C6612 photo sticker paper: 10 x 15 cm (4 x 6 inch), 16 rectangular or oval stickers per page
Image file formats	JPEG Baseline TIFF 24-bit RGB uncompressed interleaved TIFF 24-bit YCbCr uncompressed interleaved TIFF 24-bit RGB packbits interleaved TIFF 8-bit gray uncompressed/packbits TIFF 8-bit palette color uncompressed/packbits TIFF 1-bit uncompressed/packbits/1D Huffman
Video file formats	Motion-JPEG AVI Motion-JPEG QuickTime MPEG-1
Memory cards	CompactFlash Type I and II

(continued)

Category	Specifications
	Microdrive MultiMediaCard Secure Digital Memory Sticks xD-Picture Card
Memory card-supported file formats	Printing: See Supported file formats Saving: All file formats
Paper tray – media sizes supported	Main tray 7.6 x 12.7 cm to 21.6 x 35.6 cm (3 x 5 inch to 8.5 x 14 inch) Photo cassette Output tray All supported sizes
Paper tray capacity	Main tray 100 sheets of plain paper 15 envelopes 20–40 cards (depending on thickness) 20 sheets of labels 25 transparencies, iron-on transfers, or photo paper Photo cassette 20 sheets of photo paper Output tray 50 sheets of plain paper 10 cards or envelopes 25 sheets of labels or iron-on transfers
Power consumption	Printing: 21.0 W AC Idle: 5.3 W AC
Power requirements	Input frequency: 50/60 Hz, (+/- 3Hz) Input voltage Power supply model number 0957–2083: 200 to 240, Vac (+/- 10%) Power supply model number 0957–2084: 100 to 240, Vac (+/- 10%)
Environmental specifications	Recommended temperature range: 15–30° C (59–86° F) Maximum temperature range: 10–35° C (50–95° F) Storage temperature range: -30–65° C (-22–149° F) Recommended humidity range: 20–80% RH Maximum humidity range: 15–80% RH
Print cartridges	1 HP Black 1 HP Tri-color 1 HP Photo

(continued)

Category	Specifications
	<p>1 HP Gray Photo</p> <p>Note The print cartridge numbers you can use with this printer appear on the back cover of this guide.</p>
Print speed (maximum)	<p>Black printouts: 30 pages per minute</p> <p>Color printouts: 24 pages per minute</p> <p>Photos: 27 seconds for each 10 x 15 cm (4 x 6 inch) photo</p>
Connectivity	<p>USB 2.0 full-speed: Microsoft Windows 98, 2000 Professional, Me, XP Home, and XP Professional; Mac OS X 10.2 and greater)</p> <p>PictBridge: Microsoft Windows 98, 2000 Professional, Me, XP Home, and XP Professional; Mac OS X 10.2 and greater</p> <p>Bluetooth: Microsoft Windows XP Home and XP Professional</p>
USB support	<p>Universal Serial Bus (USB): 2.0 full-speed compliant cable. 10 feet (3 meters) or less in length. (Microsoft Windows 98, 2000 Professional, Me, XP Home, and XP Professional; Mac OS X 10.2 and greater.)</p>

HP printer limited warranty statement

HP product	Duration of limited warranty
Software	90 days
Print cartridges	Until the HP ink is depleted or the "end of warranty" date printed on the cartridge has been reached, whichever occurs first. This warranty does not cover HP ink products that have been refilled, remanufactured, refurbished, misused, or tampered with.
Accessories	1 year
Printer peripheral hardware (see the following for details)	1 year

A. Extent of limited warranty

1. Hewlett-Packard (HP) warrants to the end-user customer that the HP products specified above will be free from defects in materials and workmanship for the duration specified above, which duration begins on the date of purchase by the customer.
2. For software products, HP's limited warranty applies only to a failure to execute programming instructions. HP does not warrant that the operation of any product will be uninterrupted or error free.
3. HP's limited warranty covers only those defects that arise as a result of normal use of the product, and does not cover any other problems, including those that arise as a result of:
 - a. Improper maintenance or modification;
 - b. Software, media, parts, or supplies not provided or supported by HP;
 - c. Operation outside the product's specifications;
 - d. Unauthorized modification or misuse.
4. For HP printer products, the use of a non-HP ink cartridge or a refilled ink cartridge does not affect either the warranty to the customer or any HP support contract with the customer. However, if printer failure or damage is attributable to the use of a non-HP or refilled ink cartridge, HP will charge its standard time and materials charges to service the printer for the particular failure or damage.
5. If HP receives, during the applicable warranty period, notice of a defect in any product which is covered by HP's warranty, HP shall either repair or replace the product, at HP's option.
6. If HP is unable to repair or replace, as applicable, a defective product which is covered by HP's warranty, HP shall, within a reasonable time after being notified of the defect, refund the purchase price for the product.
7. HP shall have no obligation to repair, replace, or refund until the customer returns the defective product to HP.
8. Any replacement product may be either new or like-new, provided that it has functionality at least equal to that of the product being replaced.
9. HP products may contain remanufactured parts, components, or materials equivalent to new in performance.
10. HP's Limited Warranty Statement is valid in any country where the covered HP product is distributed by HP. Contracts for additional warranty services, such as on-site service, may be available from any authorized HP service facility in countries where the product is distributed by HP or by an authorized importer.

B. Limitations of warranty

TO THE EXTENT ALLOWED BY LOCAL LAW, NEITHER HP NOR ITS THIRD PARTY SUPPLIERS MAKES ANY OTHER WARRANTY OR CONDITION OF ANY KIND, WHETHER EXPRESS OR IMPLIED WARRANTIES OR CONDITIONS OF MERCHANTABILITY, SATISFACTORY QUALITY, AND FITNESS FOR A PARTICULAR PURPOSE.

C. Limitations of liability

1. To the extent allowed by local law, the remedies provided in this Warranty Statement are the customer's sole and exclusive remedies.
2. TO THE EXTENT ALLOWED BY LOCAL LAW, EXCEPT FOR THE OBLIGATIONS SPECIFICALLY SET FORTH IN THIS WARRANTY STATEMENT, IN NO EVENT SHALL HP OR ITS THIRD PARTY SUPPLIERS BE LIABLE FOR DIRECT, INDIRECT, SPECIAL, INCIDENTAL, OR CONSEQUENTIAL DAMAGES, WHETHER BASED ON CONTRACT, TORT, OR ANY OTHER LEGAL THEORY AND WHETHER ADVISED OF THE POSSIBILITY OF SUCH DAMAGES.

D. Local law

1. This Warranty Statement gives the customer specific legal rights. The customer may also have other rights which vary from state to state in the United States, from province to province in Canada, and from country to country elsewhere in the world.
2. To the extent that this Warranty Statement is inconsistent with local law, this Warranty Statement shall be deemed modified to be consistent with such local law. Under such local law, certain disclaimers and limitations of this Warranty Statement may not apply to the customer. For example, some states in the United States, as well as some governments outside the United States (including provinces in Canada), may:
 - a. Preclude the disclaimers and limitations in this Warranty Statement from limiting the statutory rights of a consumer (e.g., the United Kingdom);
 - b. Otherwise restrict the ability of a manufacturer to enforce such disclaimers or limitations; or
 - c. Grant the customer additional warranty rights, specify the duration of implied warranties which the manufacturer cannot disclaim, or allow limitations on the duration of implied warranties.
3. THE TERMS IN THIS WARRANTY STATEMENT, EXCEPT TO THE EXTENT LAWFULLY PERMITTED, DO NOT EXCLUDE, RESTRICT, OR MODIFY, AND ARE IN ADDITION TO, THE MANDATORY STATUTORY RIGHTS APPLICABLE TO THE SALE OF THE HP PRODUCTS TO SUCH CUSTOMERS.

HP Limited Warranty

Dear Customer,

You will find below the name and address of the HP entity responsible for the performance of the HP Limited Warranty in your country.

You may have additional statutory rights against the seller based on your purchase agreement. Those rights are not in any way affected by this HP Limited Warranty.

Ireland: Hewlett-Packard Ireland Ltd, 30 Herbert Street IRL-Dublin 2

United Kingdom: Hewlett-Packard Ltd, Cain Road, Bracknell, GB-Berks RG12 1HN

Index

- A**
 - Adaptive Lighting 24
 - aligning print cartridges 35
 - alignment page 35
 - antique coloration 25
- B**
 - Bluetooth
 - connecting to printer 15
 - menu settings 6
 - troubleshooting 51
 - borderless photos
 - selecting layout 19
 - borderless prints 25
 - buttons 5
- C**
 - camera-selected photos 21
 - cameras
 - connecting to printer 15
 - direct-printing 27
 - PictBridge 27
 - port 4
 - printing from 27
 - cartridges. *See* print cartridges
 - cleaning
 - print cartridges 33
 - printer 33
 - computer
 - printing from 3, 31
 - printing without 15
 - system requirements 55
 - control panel 5
 - cropping photos 25
 - Customer Care 53
- D**
 - date and time stamps 25
 - digital cameras. *See* cameras
 - documentation, printer 3
 - DPOF files 21
- E**
 - error messages 46
- F**
 - file formats, supported 18
 - framing photos 25
- H**
 - help. *See* troubleshooting
 - help, onscreen 3
 - HP direct-printing digital cameras 27
 - HP Image Zone 31
 - HP Image Zone Express 31
 - HP Instant Share 31, 32
 - HP iPod 15
 - HP Software Update 31
- I**
 - ink level, checking 34
 - inserting
 - memory cards 16
 - print cartridges 12
- J**
 - JPEG file format 18
- L**
 - layout, selecting 19
 - lights 6
 - loading paper 10
- M**
 - memory cards
 - inserting 16
 - printing photo index 18
 - removing 24
 - supported file formats 18
 - menu, printer 6
- O**
 - onscreen Help 3
- P**
 - paper
 - buying and choosing 9
 - loading 10
 - maintaining 9, 37
 - sizes 56
 - trays 4
 - photos
 - antique coloration 25
 - cropping 25
 - date and time stamp 25
 - framing 25
 - improving quality 24
 - index 18
 - printing 21
 - red-eye removal 24
 - selecting for print 20
 - selecting layout 19
 - sepia tones 25
 - supported file formats 18
 - zooming 25
 - PictBridge cameras 27
 - print cartridges
 - aligning 35
 - cleaning 33
 - inserting 12
 - replacing 12
 - storing 13, 37
 - testing 34
 - printer
 - cleaning 33
 - connecting 15
 - documentation 3
 - error messages 46
 - menu 6
 - parts 4
 - specifications 56
 - storing 36
 - printer help
 - accessing 3
 - onscreen 3
 - printer software
 - updating 36
 - printer software, updating 31
 - printing
 - from a computer 3, 31
 - from a memory card 21
 - from BlueTooth device 15
 - from cameras 27
 - from memory cards 15
 - from PictBridge camera 15

- multiple copies 20
- multiple photos 20
- photo index 18
- selecting layout 19
- test page 34
- without computer 15

Q

- quality
 - photo paper 37
 - photos 24
 - printing test page 34

R

- red-eye removal 24
- regulatory notices 63
- removing memory cards 24
- replacing print cartridges 12

S

- sepia tones 25
- slide show 25
- SmartFocus 24
- specifications 55
- storing
 - photo paper 37
 - print cartridges 13, 37
 - printer 36
- system requirements 55

T

- test page 34
- TIFF file format 18
- trays, paper 4
- troubleshooting
 - Bluetooth 51
 - Customer Care 53
 - error messages 46
 - flashing lights 39

U

- USB
 - port 4
 - specifications 55

V

- video action prints 23

Z

- zooming and cropping 25

Regulatory notices

Hewlett-Packard Company

This device complies with part 15 of the FCC Rules. Operation is subject to the following two conditions:

- This device may not cause harmful interference, and
- This device must accept any interference received, including interference that may cause undesired operation.

Pursuant to Part 15.21 of the FCC Rules, any changes or modifications to this equipment not expressly approved by Hewlett-Packard Company may cause harmful interference, and void your authority to operate this equipment. Use of a shielded data cable is required to comply with the Class B limits of Part 15 of the FCC Rules.

For further information, contact: Hewlett-Packard Company, Manager of Corporate Product Regulations, 3000 Hanover Street, Palo Alto, CA 94304, (650) 857-1501.

Note

This equipment has been tested and found to comply with the limits for a Class B digital device, pursuant to part 15 of the FCC rules. These limits are designed to provide reasonable protection against harmful interference in a residential installation. This equipment generates, uses, and can radiate radio frequency energy and, if not installed and used in accordance with the instructions, can cause harmful interference to radio communications. However, there is no guarantee that interference will not occur in a particular installation. If this equipment does cause harmful interference to radio or television reception, which can be determined by turning the equipment off and on, the user is encouraged to try to correct the interference by one or more of the following measures:

- Reorient or relocate the receiving antenna.
- Increase the separation between the equipment and the receiver.
- Connect the equipment into an outlet on a circuit different from that to which the receiver is connected.
- Consult the dealer or an experienced radio/TV technician for help.

LED indicator statement

The display LEDs meet the requirements of EN 60825-1.

사용자 안내문 (B급 기기)

이 기기는 비업무용으로 전자파장애검정을 받은 기기로서, 주거지역에서는 물론 모든 지역에서 사용할 수 있습니다.

この装置は、情報処理装置等電波障害自主規制協議会（VCCI）の基準に基づくクラスB情報技術装置です。この装置は、家庭環境で使用することを目的としていますが、この装置がラジオやテレビジョン受信機に近接して使用されると受信障害を引き起こすことがあります。
取り扱い説明書に従って正しい取り扱いをして下さい。

製品には、同梱された電源コードをお使い下さい。
同梱された電源コードは、他の製品では使用出来ません。

